

Refrigerant
R410A
INVERTER

AIRSTAGE™ V-II

Variable Refrigerant Flow System

Multi Air Conditioning System for Buildings



FUJITSU GENERAL LIMITED

All for Comfort

Smart and cutting edge design

Extensive lineup from 8HP to 48HP in 2HP increment

Connectable indoor unit capacity ratio up to 150%



High Efficiency Operating System

EER/COP has been significantly improved by unique inverter technology and refrigerant control technology.



Installation Flexibility

Total pipe length of 1,000m and 150m actual pipe length. From small to large buildings, any application can be supported.

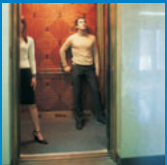

Compact Design

The outdoor unit size has been significantly reduced by optimizing of equipment. This allows for a reduction in the required installation area floor space.



User Friendly Central Control

Diverse building air conditioning control functions can be controlled easily by central air conditioning control.



AIRSTAGE™ V-II

Variable Refrigerant Flow System



FEATURES

High Efficiency Operation	4
Design Versatility	6
High Reliability	8
Easy Installation	10
Comfort and Convenience	12
Easy Service & Maintenance	14

OUTDOOR UNITS

Lineup	16
Specifications	18
Dimensions	20

INDOOR UNITS

Lineup.....	22
Compact Cassette	24
Cassette	26
Low Static Pressure Duct	28
Slim Duct	30
Medium Static Pressure Duct	32
High Static Pressure Duct	34
Floor / Ceiling	36
Ceiling	38
Wall Mounted	40

CONTROLLER

Control System	44
Wiring System	46
Comparison table of Controllers	47
Wired Remote Controller (Touch Panel) ..	48
Wired Remote Controller	50
Simple Remote Controller	51
Wireless Remote Controller	52
IR Receiver Unit	53
IR Receiver Kit	53
Group Remote Controller	54
Central Remote Controller.....	56
Touch Panel Controller	58
System Controller (Software)	60

CONVERTOR & ADAPTOR

Network Convertor	64
Network Convertor for LONWORKS®	65
BACnet® Gateway (Software)	66
Signal Amplifier	67
External Switch Controller	67

SERVICE & MONITORING

Service Tool (Software)	68
Web Monitoring Tool (Software)	70

DESIGN SUPPORT

Energy Recovery Ventilator	72
Auto Louver Grille Kit (Option).....	74
Building Information Modeling (BIM) ..	75
Design Simulator	76

OPTION

Optional Parts	78
----------------------	----

REFERENCE

Applications	81
--------------------	----



Advanced system considers high efficiency operation

High Efficiency Operation

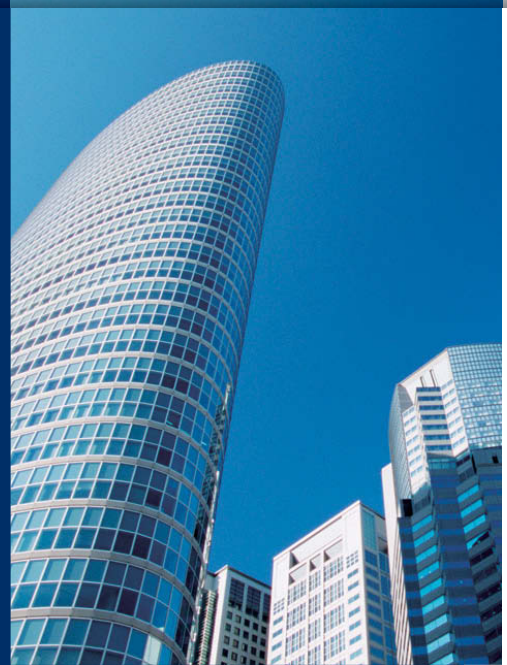

Energy saving technology that boosted operation efficiency



Powerful large propeller fan
By using CFD*1 technology, A newly designed fan achieves high performance and low noise operation.
*1. CFD = Computational Fluid Dynamics



DC fan motor
Power consumption has been reduced by 25% compared to previous models by using a compact and high performance DC fan motor.



Subcool heat exchanger
High Heat Exchange efficiency is achieved by using an internal projection shape double pipe construction.



Sine-wave DC inverter control
High efficiency operation is realized by using a sine wave DC inverter control.

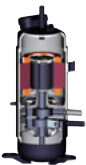

DC twin rotary compressor
Significantly greater efficiency is realized by use of a large capacity DC twin rotary compressor with substantially increased refrigerant intake and compression efficiency.



4-face heat exchanger
Heat exchange efficiency is significantly improved by the introduction of a new 4-face heat exchanger that increases effective surface area.

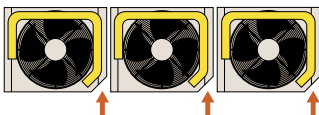
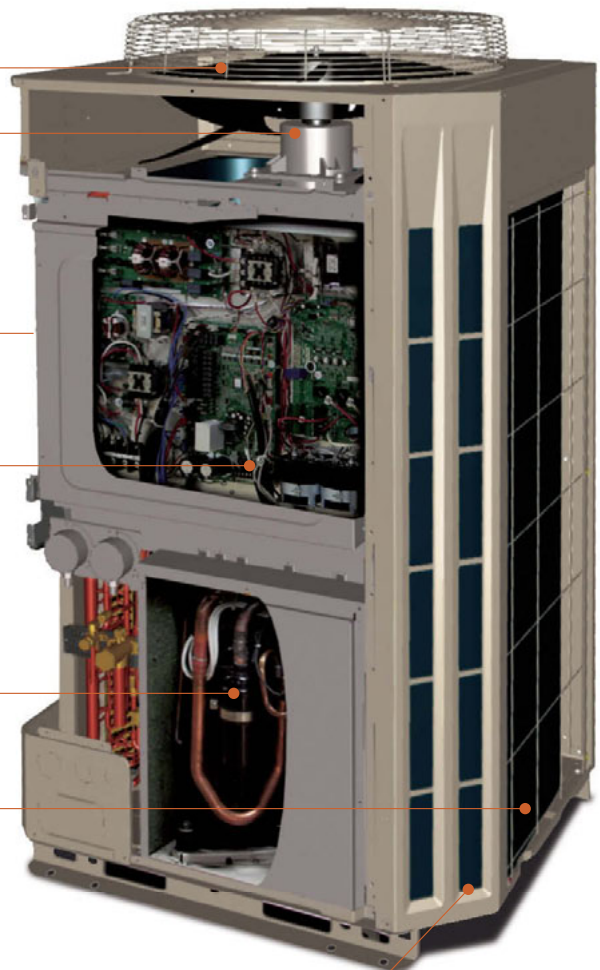

Front intake port (corner cut air inhaling structure)
In multiple outdoor unit installations, the unique front intake design improves airflow into the Heat Exchanger.

Significantly improved EER/COP

Significantly greater efficiency is realized by the use of a DC twin rotary compressor, inverter technology, and large heat exchanger.

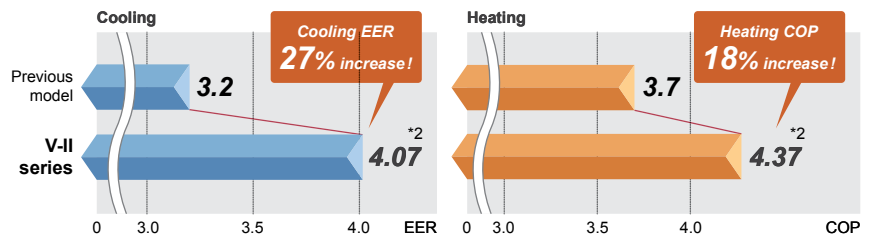

* "EER/COP" is the coefficient of performance [= capacity (kW) ÷ input power (kW)].
 *EER/COP values are based on our own testing method.
 *2. The data refers to an 8HP outdoor unit.

Energy efficiency combination

Choice of space saving or energy efficiency combinations



Various energy saving features

Room temperature set point limitation

The minimum and maximum temperature range can be set giving further energy saving while considering the comfort of the occupants.

Auto-off timer

Each remote controller is equipped with an OFF timer function that automatically stops operation when a fixed time has elapsed from the start of operation. This prevents waste of energy.
 (Note : Except simple remote controller)

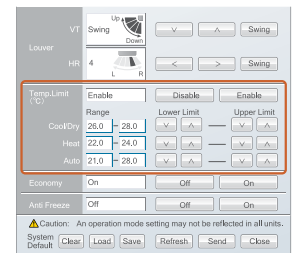
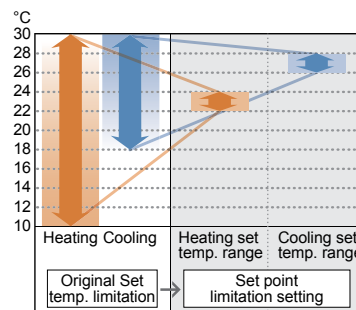

Operation setting (System Controller)

Capacity save operation

Operation capacity can be set in 5 steps for rated capability. The power consumption at peak is cut down and the maximum load is suppressed.

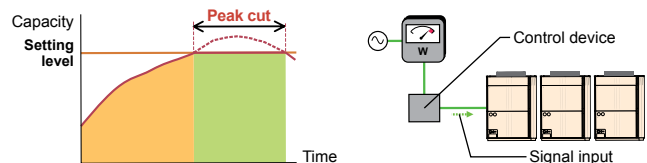

Economy operation

Economy operation can be set by remote controller. The temperature setting is offset automatically over a certain period of time.

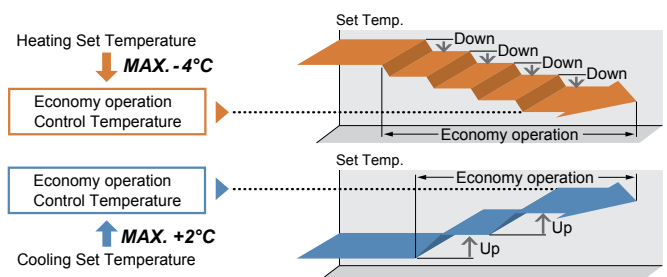

FEATURES

V-II systems can be applied to a wide variety of Building applications due to the reduced outdoor unit size and piping length capabilities

Design Versatility



Overall piping length 1,000m

World's top class overall piping length of 1,000m allows for application in a wide variety buildings.

High static pressure of 80Pa

The outdoor unit can have a condenser hood easily connected with a static pressure of 80Pa standard. This allows outdoor units to be installed within plant rooms in high rise buildings.

Powerful discharge with an external static pressure of 80Pa.

80Pa
as standard

Previous model

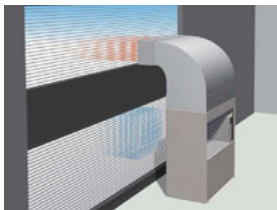

V-II series

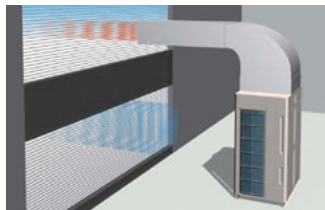

Large diameter fan and DC motor has been utilized allowing an external static pressure of 80Pa. This is approximately 2.6 times greater than the previous model.

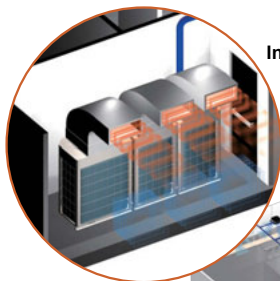

Installation Example

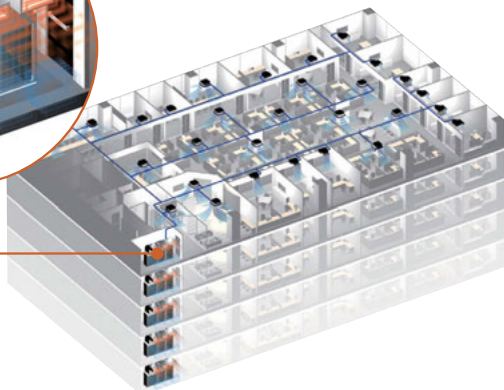

Total pipe length
1,000m^{*1} max.

Height difference between outdoor and indoor units

50m max.

For the outdoor unit stated below : 40m max.

Actual pipe length
150m max.

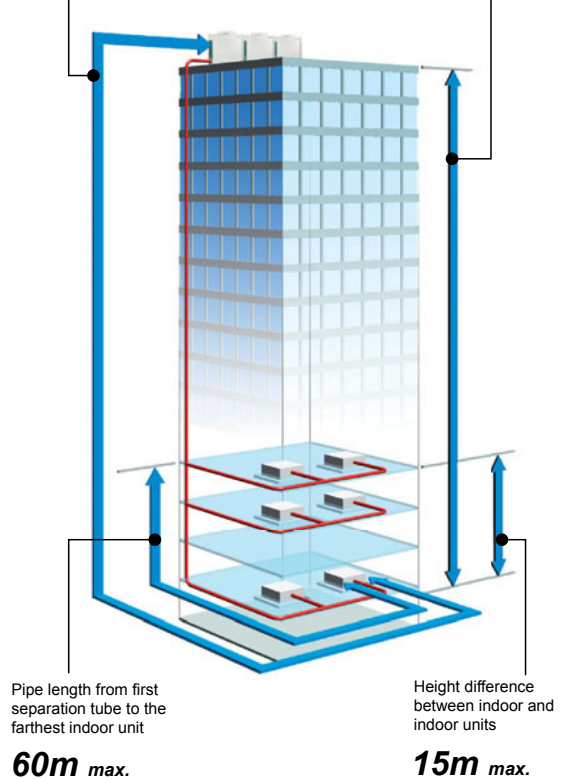

*1. Note : When there is 1 outdoor unit, the maximum is 700m.

Space saving and compact size

Compact size has been achieved by significantly reducing the width of the outdoor units compared to previous models.

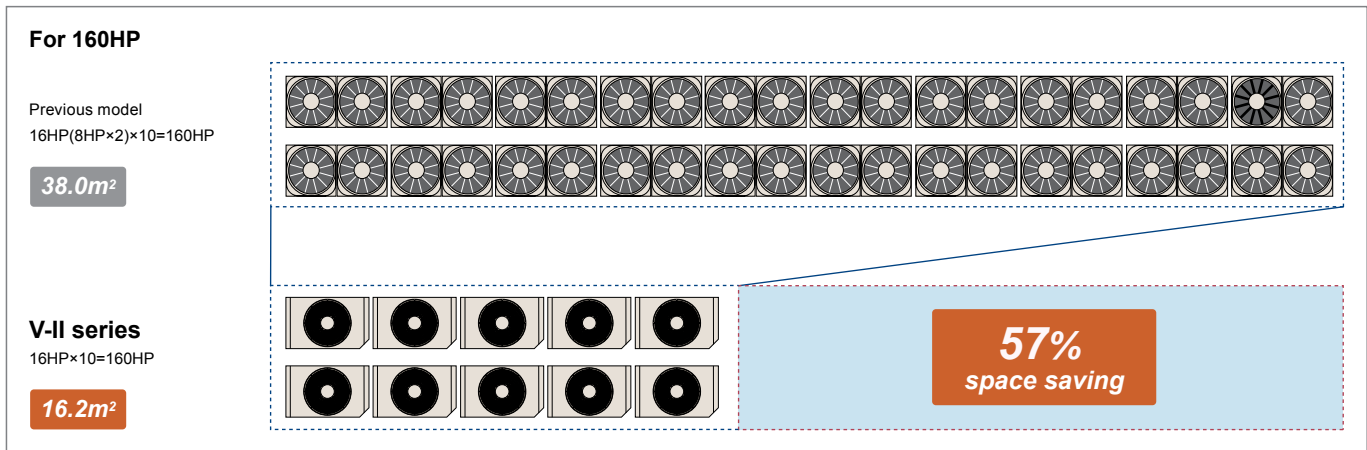
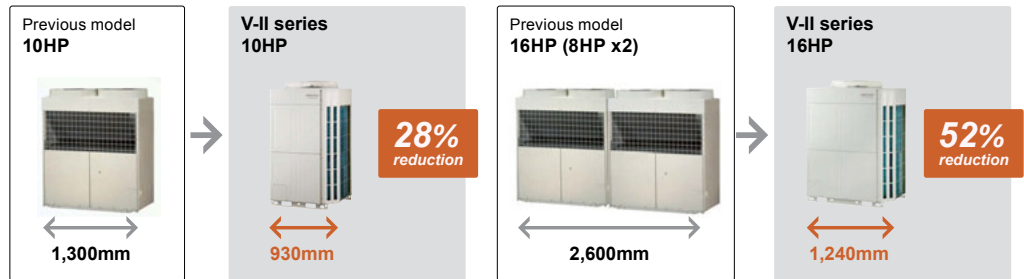

High capacity connection

Various combinations from 8HP to 48HP with 2HP increments. 11 types, 51 models of indoor units can be selected ranging from 2.2kW to 25kW in capacity. A maximum of 150% indoor unit connectable capacity.

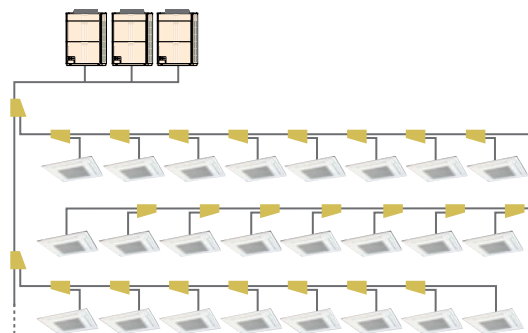

Note : When indoor unit connected capacity is greater than 100%, individual indoor units will operate at a slightly lower capacity when maximum capacity is required.

Wide operating range

Installation in extreme temperature conditions is possible due to an increase in operational range.

Cooling : -15°C~46°C
 Heating : -20°C~21°C

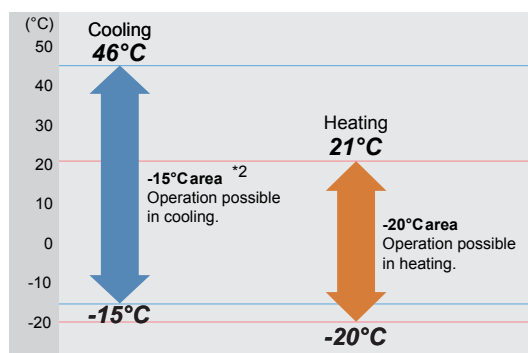

*2. Note : When a multiple outdoor unit connection is used, operating range is from -5°C to 46°C in cooling.

FEATURES

High reliability considering long-term safety and confidence

High Reliability

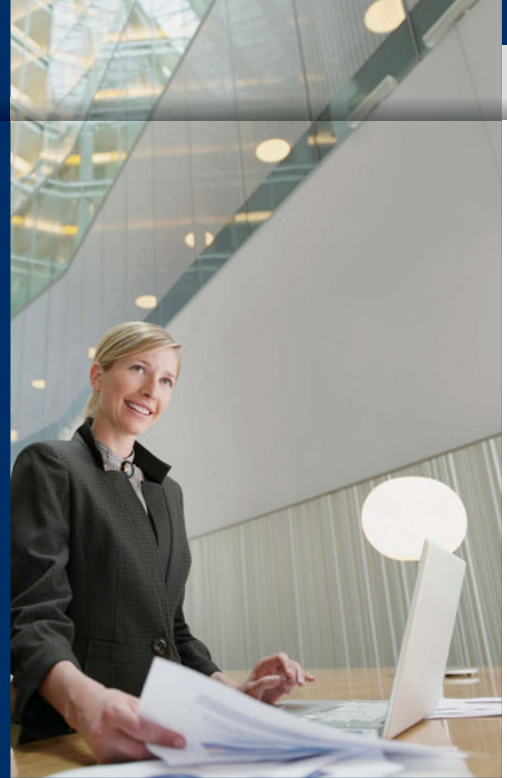

Life-extending operation

Outdoor unit rotational operation

The compressor starting order is rotated so that the running time is shared.

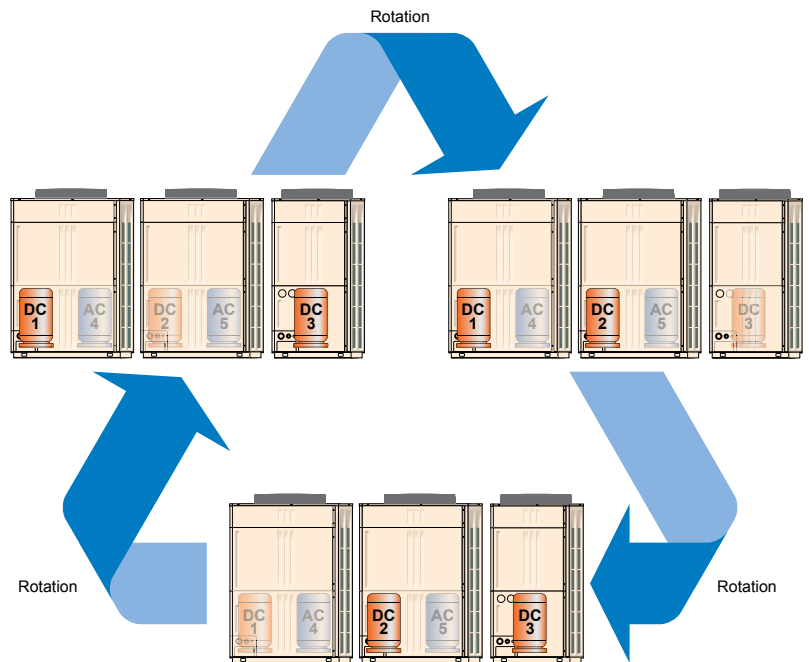
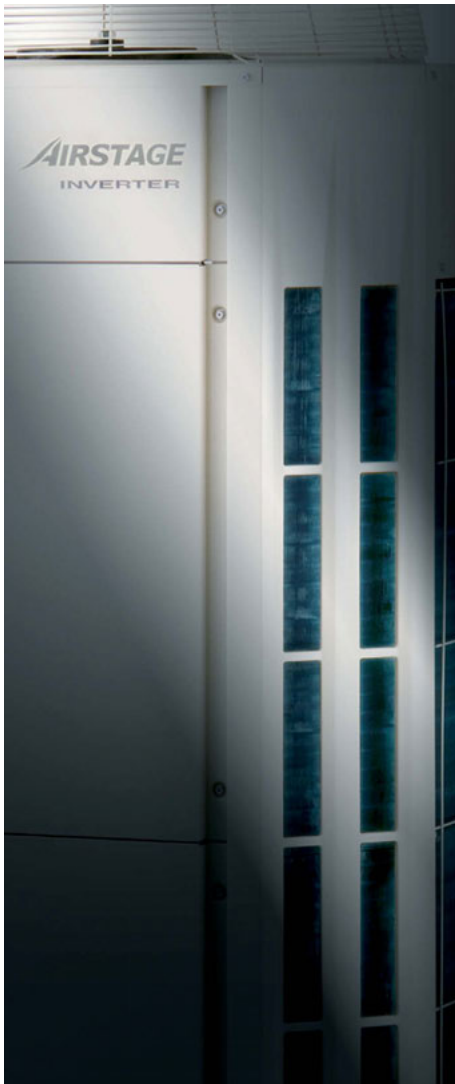

Note: The inverter compressors start in priority.
Rotational operation is alternated by the start / stop timing of the compressors

Backup operation

If one of two compressors malfunctions, it will not affect the operation of the remaining outdoor units.

Outdoor Units

If one of compressor fails, backup operation will be performed by the remaining compressors as emergency.*1

Indoor unit continuous operation

Each indoor unit is controlled individually on the system network. This allows all indoor units to continue to operate unaffected even if an error should occur at any indoor unit's on the VRF network system.

*1 Note: Backup operation may not be possible depending on the combination and trouble state.

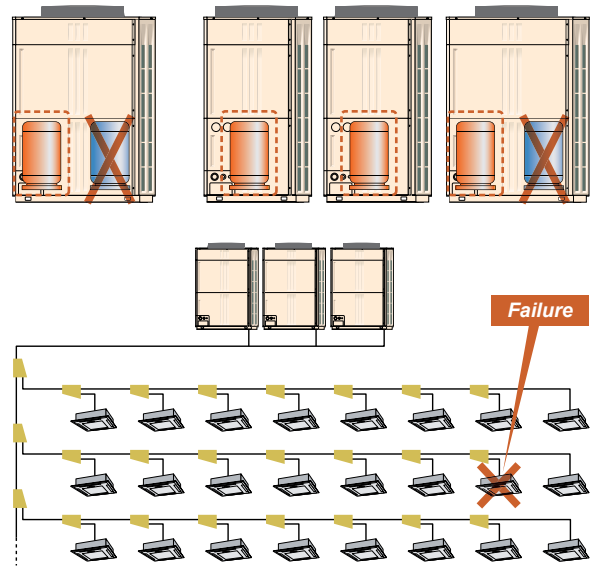

Adoption of blue fin heat exchanger

Corrosion resistant of the heat exchanger has been improved by the introduction of blue fin treatment to the outdoor unit's heat exchanger.

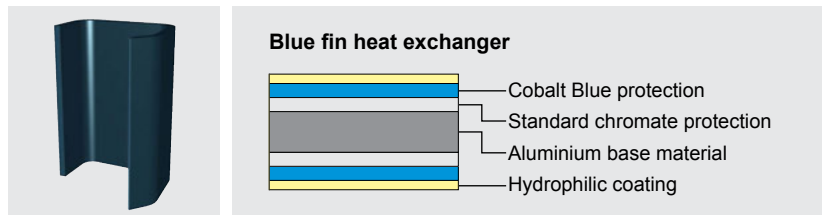

Remote monitoring

The Web Monitoring system allows you view system operation at all times over the internet ensuring trouble free operation.

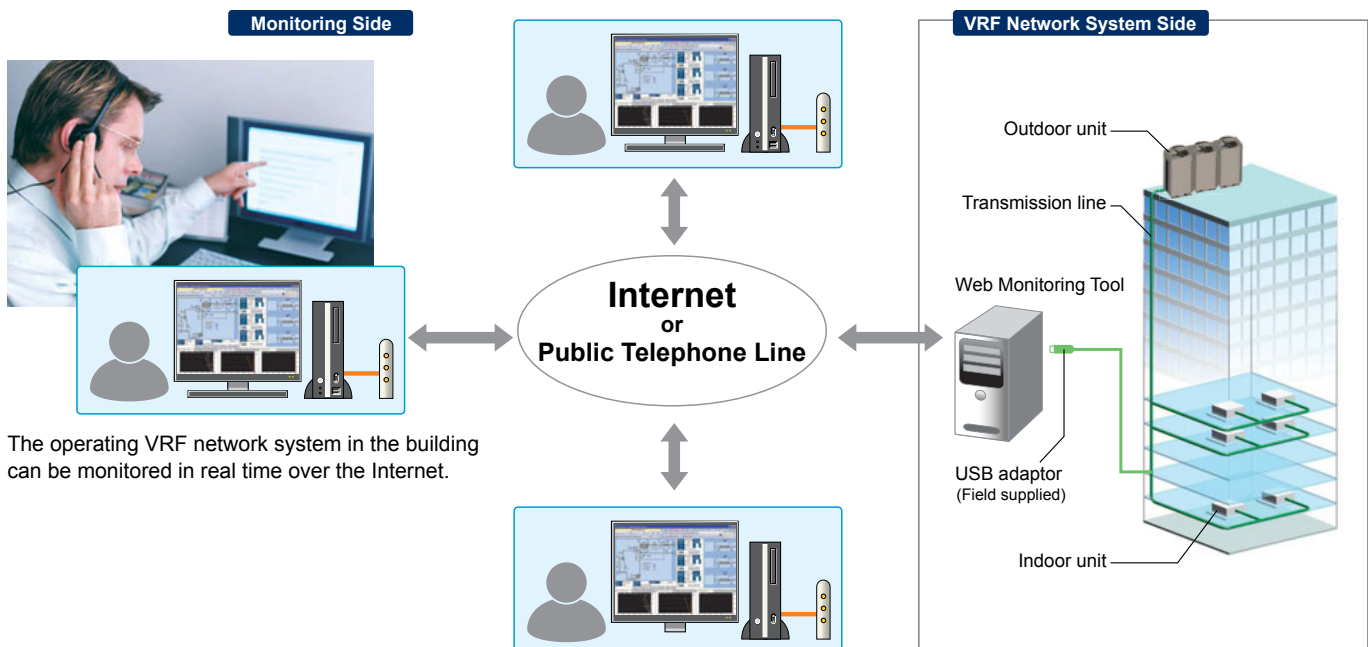

The operating VRF network system in the building can be monitored in real time over the Internet.

FEATURES

From transportation of the product to address setting for commissioning, significant improvements have been made which reduce the cost of installation.

Easy Installation

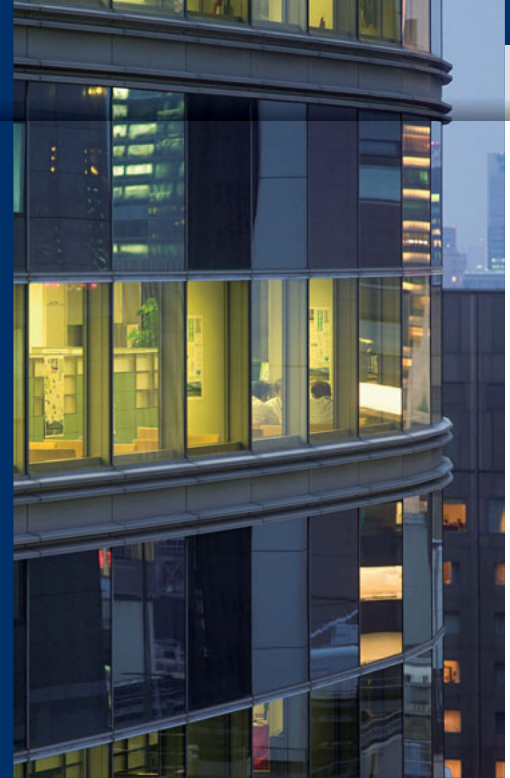

Easily transported

Light weight



20%
weight reduction
(Than Previous model)

Note: In the case of 14HP

Easily craned using lifting belt hooks

Design of outdoor unit allows for lifting straps to be used

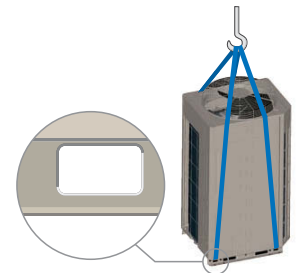

Can be transported in a small elevator



Transporting by forklift

Transport with forklift is possible.

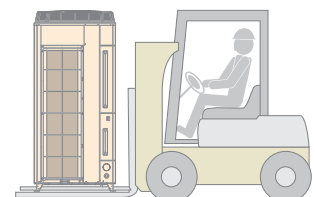

Easy piping connection

The need for an oil equalization pipe as required on the previous model has been removed. The installation costs have been reduced by employing a simple 2 pipe connection

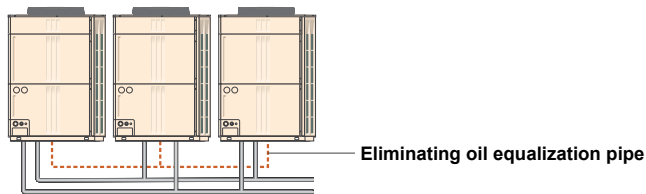

Simple signal line connection

Installation is made easier as the communication wiring can be connected continuously to any component.

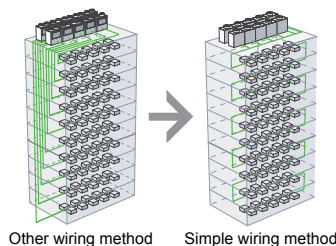

Up to maximum length **3,600m**

V-II series

Note: In a multiple refrigerant system installation, Automatic addressing sequence cannot be initiated

Easy access

By adopting a L-Shape front panel that can be removed, the work space for installation and service has been significantly expanded by this new design. For multiple installations, work is performed easily and efficiently even in a narrow space.

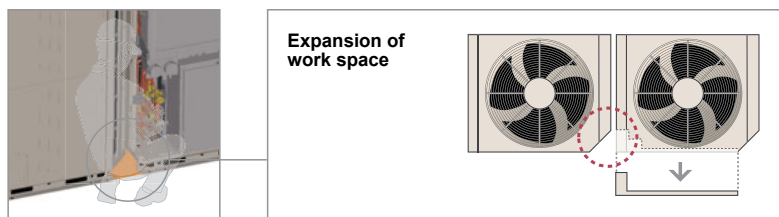

Flexible piping connection

Piping and wiring are available to the front, left and right, and bottom.

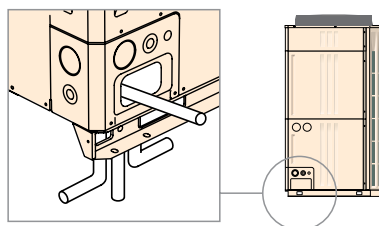

Automatic address setting

The address of each indoor unit can be automatically set by button switch of outdoor unit.

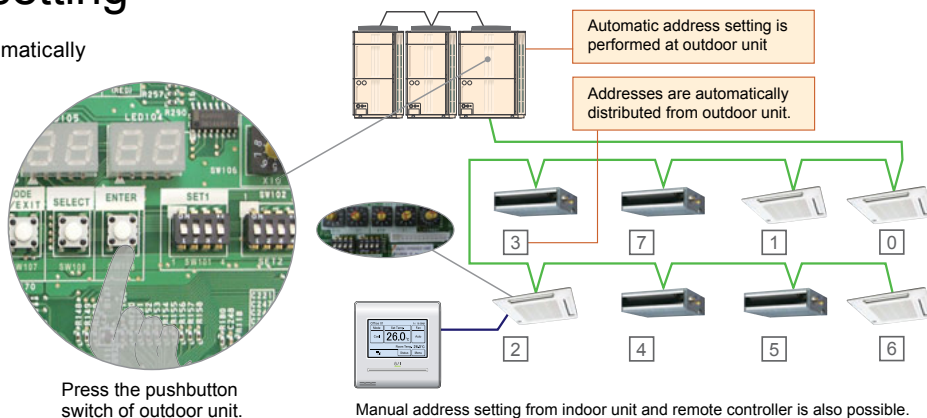

Low noise, easy operational settings, and comfortable temperature adjustment allows for V-II systems to be used in building air conditioning applications.

Comfort and Convenience



Quiet operation

Low noise mode

Two low noise modes can be selected automatically by quiet priority setting and capacity priority setting depending on the usage environment and outside temperature load.

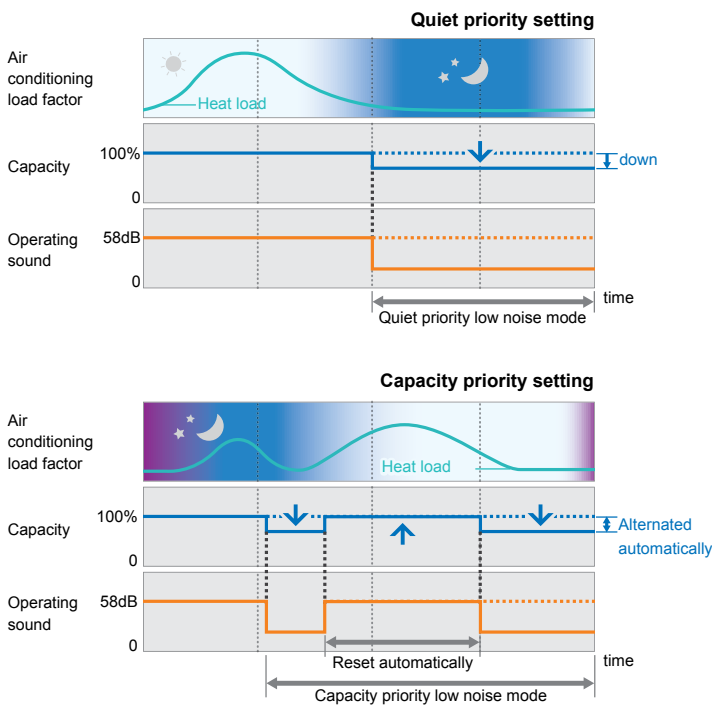

Low noise design

Compressor noise has been significantly reduced by shielding the compressor compartment.

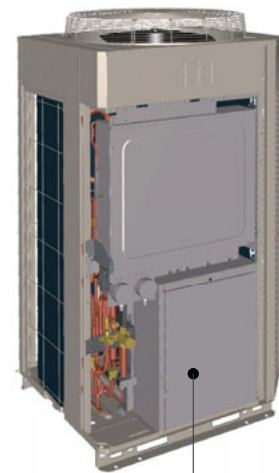

Compressor compartment

Indoor unit

Low noise indoor unit lineup



Auto changeover function

Auto changeover setting allows for the product to easily switch between cooling and heating modes regardless of the operation mode of other indoor units. This can be done via specific indoor unit with wired remote controller. This ensures comfortable operation all year round.



Precision refrigerant flow control

Precision and Smooth refrigerant flow control is achieved by using a DC Inverter control in conjunction with individual indoor unit electronic expansion valve control. This allows for a high precision comfortable temperature control of $\pm 0.5^{\circ}\text{C}$.

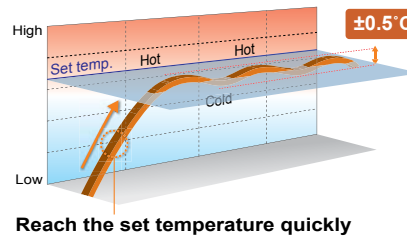

Thermal change of the room
*Simulation in heating operation.

Comfortable operation is achieved due to a small variation of room temperature

Individual air conditioning control

The desired temperature conditions of each room are met due to the Individual thermostat control of each indoor unit.

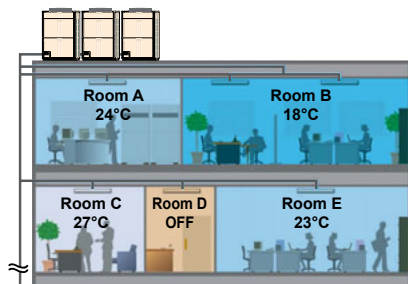

Simple central management function



Simple central control operation
Simple operation by icon display and color touch screen

Yearly schedule function
Daily starting & stopping and temperature setting are managed.

Clock setting function
The clock of each individual controller is periodically corrected.



Non-stop oil recovery operation

A comfortable room condition is maintained during oil recovery mode because the product continues to operate without stopping the cooling or heating operation.

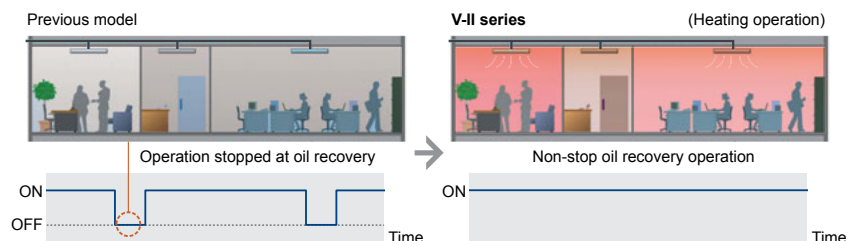

Designed for Quick Service response,
Easy maintenance and Troubleshooting

Easy Service & Maintenance

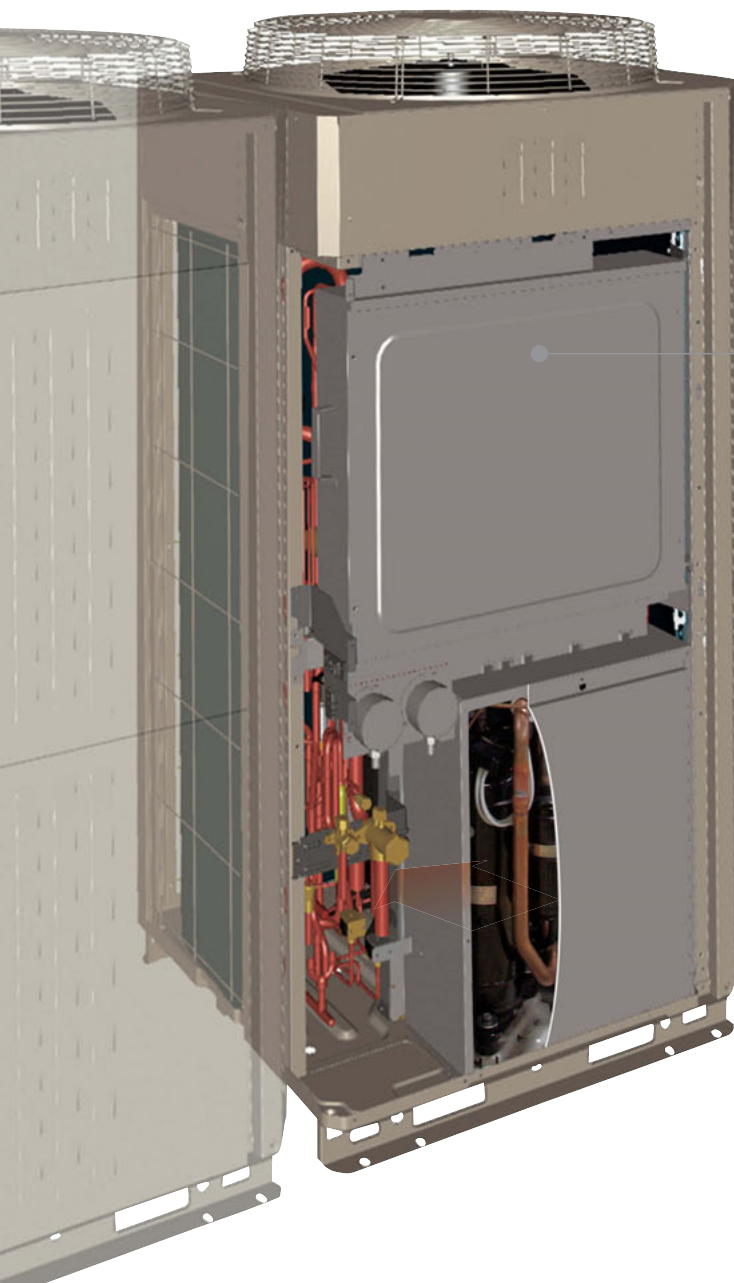

Design for easy service and maintenance

Inspection and replacement of main parts are easier due to innovative construction and an LED operational display.



Consolidated electrical components make maintenance easy
Movable PCB panel that allows for easier maintenance work behind the PCB

Easy-to-read 7-segment LED display which explains operational and trouble status

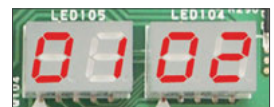

Maintenance of electrical components, valves, and compressor parts from the front is possible.

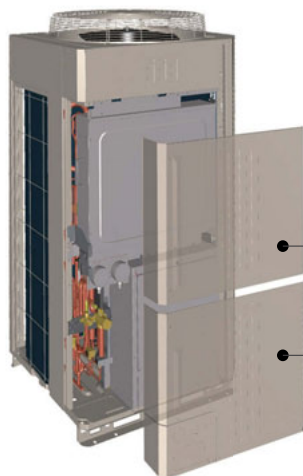

Split front panel
Split front panel allows for maintenance from top or bottom of the outdoor unit

Error status can be checked easily via the indoor unit wired controller

An error code is displayed on a liquid crystal screen.

Wired Remote Controller

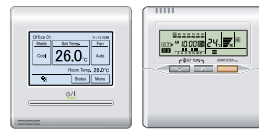

Faulty unit number
(Remote controller address)
Error code

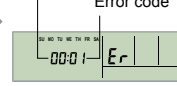

Simple Remote Controller



Remote controller address
Error code

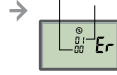

Emergency stop function

Emergency alarm can be received by indoor, outdoor units or Touch Panel Controller when they received it, all units will be stopped.

Note: In case of received Emergency alarm by Indoor / outdoor unit : All units connected within same refrigerant system will be stopped.
Touch Panel Controller : all unit connected within VRF network system with Touch Panel Controller will be stopped.

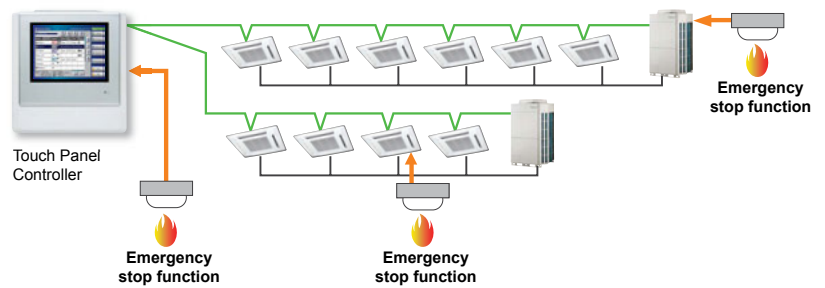

Continuous operation during maintenance

Non-stop operation

When servicing a specific indoor unit, maintenance can be performed even without turning off the other indoor units.

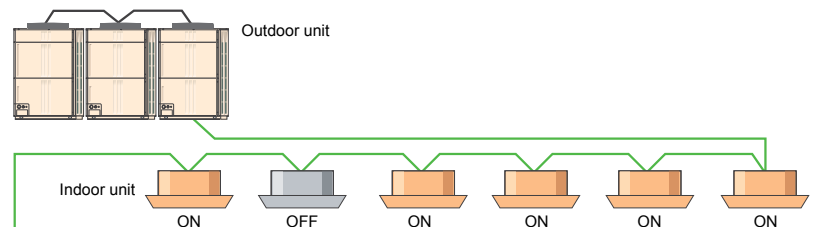

Trouble diagnosis by Service Tool

Suitable maintenance is possible by analysis of the operation data. Connection anywhere in the VRF network is easy.

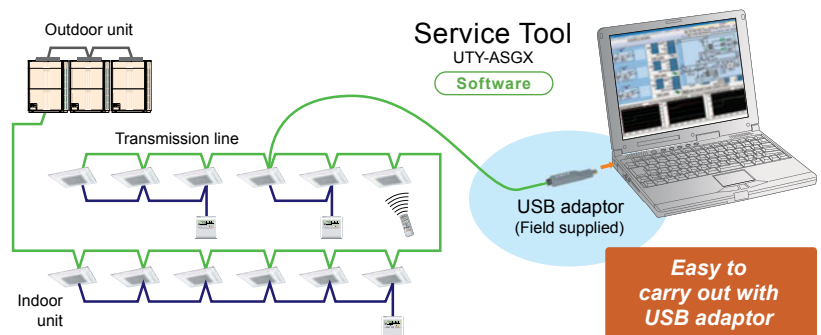

Easy to carry out with USB adaptor

Equipment Detail (Diagram)

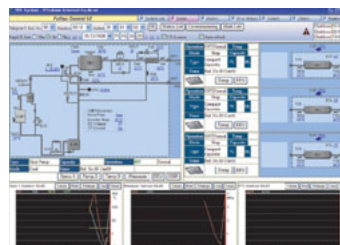

Equipment Detail (List)

Outdoor Units Lineup

Space saving combination

22.4kW (8HP)



AJ*A72LALH
UNIT : AJ*A72LALH

28.0kW (10HP)



AJ*A90LALH
UNIT : AJ*A90LALH

33.5kW (12HP)



AJ*108LALH
UNIT : AJ*108LALH

55.9kW (20HP)



AJ*180LALH
UNIT : AJ*108/A72LALH

61.5kW (22HP)



AJ*198LALH
UNIT : AJ*108/A90LALH

67.0kW (24HP)



AJ*216LALH
UNIT : AJ*108/108LALH

90.0kW (32HP)



AJ*288LALH
UNIT : AJ*144/144LALH

95.0kW (34HP)



AJ*306LALH
UNIT : AJ*108/108/A90LALH

100.5kW (36HP)



AJ*324LALH
UNIT : AJ*108/108/108LALH

123.5kW (44HP)



AJ*396LALH
UNIT : AJ*144/144/108LALH

130.0kW (46HP)



AJ*414LALH
UNIT : AJ*144/144/126LALH

135.0kW (48HP)



AJ*432LALH
UNIT : AJ*144/144/144LALH

Energy efficiency combination

44.8kW (16HP)



AJ*144LALHH
UNIT : AJ*A72/A72LALH

62.4kW (22HP)



AJ*198LALHH
UNIT : AJ*126/A72LALH

67.2kW (24HP)



AJ*216LALHH
UNIT : AJ*A72/A72/A72LALH

89.8kW (32HP)



AJ*288LALHH
UNIT : AJ*108/108/A72LALH

95.9kW (34HP)











AJ*306LALHH
UNIT : AJ*126/108/A72LALH







102.4kW (36HP)



AJ*324LALHH
UNIT : AJ*126/126/A72LALH



- Extensive line up from 8HP to 48HP in 2HP increments
- Space saving combination and Energy efficiency combination available, which can be selected to suit any air conditioning needs
- Combinations other than the followings are not recommended.

<p>40.0kW (14HP)</p>  <p>AJ*126LALH UNIT : AJ*126LALH</p>	<p>45.0kW (16HP)</p>  <p>AJ*144LALH UNIT : AJ*144LALH</p>	<p>50.4kW (18HP)</p>  <p>AJ*162LALH UNIT : AJ*A90/A72LALH</p>
<p>73.5kW (26HP)</p>  <p>AJ*234LALH UNIT : AJ*126/108LALH</p>	<p>78.5kW (28HP)</p>  <p>AJ*252LALH UNIT : AJ*144/108LALH</p>	<p>85.0kW (30HP)</p>  <p>AJ*270LALH UNIT : AJ*144/126LALH</p>
<p>107.0kW (38HP)</p>  <p>AJ*342LALH UNIT : AJ*126/108/108LALH</p>	<p>112.0kW (40HP)</p>  <p>AJ*360LALH UNIT : AJ*144/108/108LALH</p>	<p>118.5kW (42HP)</p>  <p>AJ*378LALH UNIT : AJ*144/126/108LALH</p>



<p>72.8kW (26HP)</p>  <p>AJ*234LALHH UNIT : AJ*A90/A72/A72LALH</p>	<p>78.3kW (28HP)</p>  <p>AJ*252LALHH UNIT : AJ*108/A72/A72LALH</p>	<p>84.8kW (30HP)</p>  <p>AJ*270LALHH UNIT : AJ*126/A72/A72LALH</p>
<p>113.5kW (40HP)</p>  <p>AJ*360LALHH UNIT : AJ*126/126/108LALH</p>	<p>120.0kW (42HP)</p>  <p>AJ*378LALHH UNIT : AJ*126/126/126LALH</p>	<p>125.0kW (44HP)</p>  <p>AJ*396LALHH UNIT : AJ*144/126/126LALH</p>

Specifications

Space saving combination

Rating Capacity range		HP	8	10	12	14	16	18	20	22	24
											
Model name			AJ*A72LALH	AJ*A90LALH	AJ*108LALH	AJ*126LALH	AJ*144LALH	AJ*162LALH	AJ*180LALH	AJ*198LALH	AJ*216LALH
Unit 1 Unit 2 Unit 3			AJ*A72LALH	AJ*A90LALH	AJ*108LALH	AJ*126LALH	AJ*144LALH	AJ*A90LALH AJ*A72LALH	AJ*108LALH AJ*A72LALH	AJ*108LALH AJ*A90LALH	AJ*108LALH AJ*108LALH
Maximum Connectable Indoor Unit*1			15	16	17	21	24	32	32	32	35
Indoor unit connectable capacity		Cooling kW	11.2-33.6	14.0-42.0	16.8-50.2	20.0-60.0	22.5-67.5	25.2-75.6	28.0-83.8	30.8-92.2	33.5-100.5
Power source			3 Phase ~ 400 V, 50Hz								
Capacity	Cooling	kW	22.4	28.0	33.5	40.0	45.0	50.4	55.9	61.5	67.0
	Heating	kW	25.0	31.5	37.5	45.0	50.0	56.5	62.5	69.0	75.0
Input power	Cooling	kW	5.51	7.73	9.62	11.53	14.17	13.24	15.13	17.35	19.24
	Heating	kW	5.72	7.83	9.28	11.45	12.60	13.55	15.00	17.11	18.56
EER	Cooling	W/W	4.07	3.62	3.48	3.47	3.18	3.81	3.69	3.54	3.48
COP	Heating	W/W	4.37	4.02	4.04	3.93	3.97	4.17	4.17	4.03	4.04
Air flow rate	High	m³/h	11,100	11,100	11,100	13,000	13,000	11,100 x 2	11,100 x 2	11,100 x 2	11,100 x 2
Sound pressure level*2	Cooling	dB (A)	56	58	58	60	61	60	60	61	61
	Heating	dB (A)	58	59	60	61	61	62	62	63	63
Maximum external static pressure		Pa	80	80	80	80	80	80	80	80	80
Compressor motor output		kW	3.9	3.9	3.9 + 4.5	3.9 + 4.5	3.9 + 4.5	3.9 x 2	3.9 x 2 + 4.5	3.9 x 2 + 4.5	3.9 x 2 + 4.5 x 2
Heat exchanger fin			Blue fin	Blue fin	Blue fin	Blue fin	Blue fin	Blue fin	Blue fin	Blue fin	Blue fin
Dimensions	Height	mm	1,690	1,690	1,690	1,690	1,690	1,690	1,690	1,690	1,690
	Width	mm	930	930	930	1,240	1,240	930 x 2	930 x 2	930 x 2	930 x 2
	Depth	mm	765	765	765	765	765	765	765	765	765
Weight		kg	220	220	275	303	303	220 + 220	275 + 220	275 + 220	275 + 275
Refrigerant charge		kg	11.2	11.2	11.8	11.8	11.8	11.2 x 2	11.8 + 11.2	11.8 + 11.2	11.8 x 2
Connection pipe diameter	Liquid	mm	12.70	12.70	12.70	12.70	12.70	15.88	15.88	15.88	15.88
	Gas	mm	22.22	22.22	28.58	28.58	28.58	28.58	28.58	34.92	34.92
Operation range	Cooling	°C	-15 to 46	-15 to 46	-15 to 46	-15 to 46	-15 to 46	-5 to 46	-5 to 46	-5 to 46	-5 to 46
	Heating	°C	-20 to 21	-20 to 21	-20 to 21	-20 to 21	-20 to 21	-20 to 21	-20 to 21	-20 to 21	-20 to 21













Energy efficiency combination







Rating Capacity range		HP	16	22	24	26	28	30
								
Model name			AJ*144LALHH	AJ*198LALHH	AJ*216LALHH	AJ*234LALHH	AJ*252LALHH	AJ*270LALHH
Unit 1 Unit 2 Unit 3			AJ*A72LALH AJ*A72LALH	AJ*126LALH AJ*A72LALH	AJ*A72LALH AJ*A72LALH AJ*A72LALH	AJ*A90LALH AJ*A72LALH AJ*A72LALH	AJ*108LALH AJ*A72LALH AJ*A72LALH	AJ*126LALH AJ*A72LALH AJ*A72LALH
Maximum Connectable Indoor Unit*1			30	33	36	39	42	45
Indoor unit connectable capacity		Cooling kW	22.4-67.2	31.2-93.6	33.6-100.8	36.4-109.2	39.2-117.4	42.4-127.2
Power source			3 Phase ~ 400 V, 50Hz					
Capacity	Cooling	kW	44.8	62.4	67.2	72.8	78.3	84.8
	Heating	kW	50.0	70.0	75.0	81.5	87.5	95.0
Input power	Cooling	kW	11.02	17.04	16.53	18.75	20.64	22.55
	Heating	kW	11.44	17.17	17.16	19.27	20.72	22.89
EER	Cooling	W/W	4.07	3.66	4.07	3.88	3.79	3.76
COP	Heating	W/W	4.37	4.08	4.37	4.23	4.22	4.15
Air flow rate	High	m³/h	11,100 x 2	13,000 + 11,100	11,100 x 3	11,100 x 3	11,100 x 3	13,000 + 11,000 x 2
Sound pressure level*2	Cooling	dB (A)	59	61	61	62	62	63
	Heating	dB (A)	59	62	61	62	63	63
Maximum external static pressure		Pa	80	80	80	80	80	80
Compressor motor output		kW	3.9 x 2	3.9 x 2 + 4.5	3.9 x 3	3.9 x 3	3.9 x 3 + 4.5	3.9 x 3 + 4.5
Heat exchanger fin			Blue fin	Blue fin	Blue fin	Blue fin	Blue fin	Blue fin
Dimensions	Height	mm	1,690	1,690	1,690	1,690	1,690	1,690
	Width	mm	930 x 2	930 + 1,240	930 x 3	930 x 3	930 x 3	930 x 2 + 1,240
	Depth	mm	765	765	765	765	765	765
Weight		kg	220 + 220	303 + 220	220 + 220 + 220	220 + 220 + 220	275 + 220 + 220	303 + 220 + 220
Refrigerant charge		kg	11.2 x 2	11.8 + 11.2	11.2 x 3	11.2 x 3	11.8 + 11.2 x 2	11.8 + 11.2 x 2
Connection pipe diameter	Liquid	mm	12.70	15.88	15.88	15.88	15.88	19.05
	Gas	mm	28.58	34.92	34.92	34.92	34.92	34.92
Operation range	Cooling	°C	-5 to 46	-5 to 46	-5 to 46	-5 to 46	-5 to 46	-5 to 46
	Heating	°C	-20 to 21	-20 to 21	-20 to 21	-20 to 21	-20 to 21	-20 to 21

AJ* : AJY(FUJITSU), AJH(GENERAL)

Note : Specifications are based on the following conditions.
 Cooling : Indoor temperature of 27°CDB / 19°CWB, and outdoor temperature of 35°CDB / 24°CWB.
 Heating : Indoor temperature of 20°CDB / (15°CWB), and outdoor temperature of 7°CDB / 6°CWB.

Pipe length : 7.5 m; Height difference between outdoor unit and indoor unit : 0 m.
 When cooling operation will be conducted at outdoor air temperature below -5°C, the outdoor unit must be installed in a position that is higher than or equal to those of indoor units.

26	28	30	32	34	36	38	40	42	44	46	48
											
AJ*234LALH	AJ*252LALH	AJ*270LALH	AJ*288LALH	AJ*306LALH	AJ*324LALH	AJ*342LALH	AJ*360LALH	AJ*378LALH	AJ*396LALH	AJ*414LALH	AJ*432LALH
AJ*126LALH AJ*108LALH	AJ*144LALH AJ*108LALH	AJ*144LALH AJ*126LALH	AJ*144LALH AJ*144LALH	AJ*108LALH AJ*108LALH AJ*A90LALH	AJ*108LALH AJ*108LALH AJ*108LALH	AJ*126LALH AJ*108LALH AJ*108LALH	AJ*144LALH AJ*108LALH AJ*108LALH	AJ*144LALH AJ*126LALH AJ*108LALH	AJ*144LALH AJ*144LALH AJ*108LALH	AJ*144LALH AJ*144LALH AJ*126LALH	AJ*144LALH AJ*144LALH AJ*144LALH
39	42	45	48	48	48	48	48	48	48	48	48
36.8-110.2	39.3-117.7	42.5-127.5	45.0-135.0	47.5-142.5	50.3-150.7	53.5-160.5	56.0-168.0	59.3-177.7	61.8-185.2	65.0-195.0	67.5-202.5
3 Phase ~ 400 V, 50Hz											
73.5	78.5	85.0	90.0	95.0	100.5	107.0	112.0	118.5	123.5	130.0	135.0
82.5	87.5	95.0	100.0	106.5	112.5	120.0	125.0	132.5	137.5	145.0	150.0
21.15	23.79	25.70	28.34	26.97	28.86	30.77	33.41	35.32	37.96	39.87	42.51
20.73	21.88	24.05	25.20	26.39	27.84	30.01	31.16	33.33	34.48	36.65	37.80
3.48	3.30	3.31	3.18	3.52	3.48	3.48	3.35	3.36	3.25	3.26	3.18
3.98	4.00	3.95	3.97	4.04	4.04	4.00	4.01	3.98	3.99	3.96	3.97
13,000 + 11,100	13,000 + 11,100	13,000 x 2	13,000 x 2	11,100 x 3	11,100 x 3	13,000 + 11,100 x 2	13,000 + 11,100 x 2	13,000 x 2 + 11,100	13,000 x 2 + 11,100	13,000 x 3	13,000 x 3
62	63	64	64	63	63	64	64	65	65	65	66
64	64	64	64	64	65	65	65	65	65	66	66
80	80	80	80	80	80	80	80	80	80	80	80
3.9 x 2 + 4.5 x 2	3.9 x 2 + 4.5 x 2	3.9 x 2 + 4.5 x 2	3.9 x 2 + 4.5 x 2	3.9 x 3 + 4.5 x 2	3.9 x 3 + 4.5 x 3	3.9 x 3 + 4.5 x 3	3.9 x 3 + 4.5 x 3	3.9 x 3 + 4.5 x 3	3.9 x 3 + 4.5 x 3	3.9 x 3 + 4.5 x 3	3.9 x 3 + 4.5 x 3
Blue fin	Blue fin	Blue fin	Blue fin	Blue fin	Blue fin	Blue fin	Blue fin	Blue fin	Blue fin	Blue fin	Blue fin
1,690	1,690	1,690	1,690	1,690	1,690	1,690	1,690	1,690	1,690	1,690	1,690
930 + 1,240	930 + 1,240	1,240 x 2	1,240 x 2	930 x 3	930 x 3	930 x 2 + 1,240	930 x 2 + 1,240	930 + 1,240 x 2	930 + 1,240 x 2	1,240 x 3	1,240 x 3
765	765	765	765	765	765	765	765	765	765	765	765
303 + 275	303 + 275	303 + 303	303 + 303	275 + 275 + 220	275 + 275 + 275	303 + 275 + 275	303 + 275 + 275	303 + 303 + 275	303 + 303 + 275	303 + 303 + 303	303 + 303 + 303
11.8 x 2	11.8 x 2	11.8 x 2	11.8 x 2	11.8 x 2 + 11.2	11.8 x 3	11.8 x 3	11.8 x 3	11.8 x 3	11.8 x 3	11.8 x 3	11.8 x 3
15.88	15.88	19.05	19.05	19.05	19.05	19.05	19.05	19.05	19.05	19.05	19.05
34.92	34.92	34.92	34.92	34.92	41.27	41.27	41.27	41.27	41.27	41.27	41.27
-5 to 46	-5 to 46	-5 to 46	-5 to 46	-5 to 46	-5 to 46	-5 to 46	-5 to 46	-5 to 46	-5 to 46	-5 to 46	-5 to 46
-20 to 21	-20 to 21	-20 to 21	-20 to 21	-20 to 21	-20 to 21	-20 to 21	-20 to 21	-20 to 21	-20 to 21	-20 to 21	-20 to 21

32	34	36	40	42	44
					
AJ*288LALHH	AJ*306LALHH	AJ*324LALHH	AJ*360LALHH	AJ*378LALHH	AJ*396LALHH
AJ*108LALH AJ*108LALH AJ*A72LALH	AJ*126LALH AJ*108LALH AJ*A72LALH	AJ*126LALH AJ*126LALH AJ*A72LALH	AJ*126LALH AJ*126LALH AJ*108LALH	AJ*126LALH AJ*126LALH AJ*126LALH	AJ*144LALH AJ*126LALH AJ*126LALH
48	48	48	48	48	48
44.7-134.1	48.0-143.8	51.2-153.6	56.8-170.2	60.0-180.0	62.5-187.5
3 Phase ~ 400 V, 50Hz					
89.4	95.9	102.4	113.5	120.0	125.0
100.0	107.5	115.0	127.5	135.0	140.0
24.75	26.66	28.57	32.68	34.59	37.23
24.28	26.45	28.62	32.18	34.35	35.50
3.61	3.60	3.58	3.47	3.47	3.36
4.12	4.06	4.02	3.96	3.93	3.94
11,100 x 3	13,000 + 11,100 x 2	13,000 x 2 + 11,100	13,000 x 2 + 11,100	13,000 x 3	13,000 x 3
62	63	64	64	65	65
64	64	65	65	66	66
80	80	80	80	80	80
3.9 x 3 + 4.5 x 2	3.9 x 3 + 4.5 x 2	3.9 x 3 + 4.5 x 2	3.9 x 3 + 4.5 x 3	3.9 x 3 + 4.5 x 3	3.9 x 3 + 4.5 x 3
Blue fin	Blue fin	Blue fin	Blue fin	Blue fin	Blue fin
1,690	1,690	1,690	1,690	1,690	1,690
930 x 3	930 x 2 + 1,240	930 + 1,240 x 2	930 + 1,240 x 2	1,240 x 3	1,240 x 3
765	765	765	765	765	765
275 + 275 + 220	303 + 275 + 220	303 + 303 + 220	303 + 303 + 275	303 + 303 + 303	303 + 303 + 303
11.8 x 2 + 11.2	11.8 x 2 + 11.2	11.8 x 2 + 11.2	11.8 x 3	11.8 x 3	11.8 x 3
19.05	19.05	19.05	19.05	19.05	19.05
34.92	34.92	41.27	41.27	41.27	41.27
-5 to 46	-5 to 46	-5 to 46	-5 to 46	-5 to 46	-5 to 46
-20 to 21	-20 to 21	-20 to 21	-20 to 21	-20 to 21	-20 to 21

*1 Minimum connectable indoor unit number is 2.
However ARXC72 and ARXC90 can be used signal connection.

*2 The noise value is the value when measured in an anechoic room.
When measured in the actual installed state, surrounding noise and reflections are received and the measured value is usually larger than the indicated value.

Dimensions

8, 10, 12HP

(Unit : mm)

AJ*A72LALH / AJ*A90LALH / AJ*108LALH

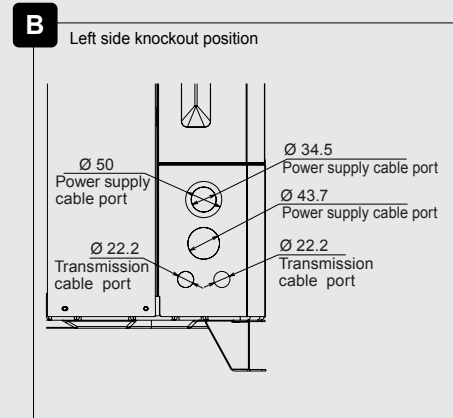
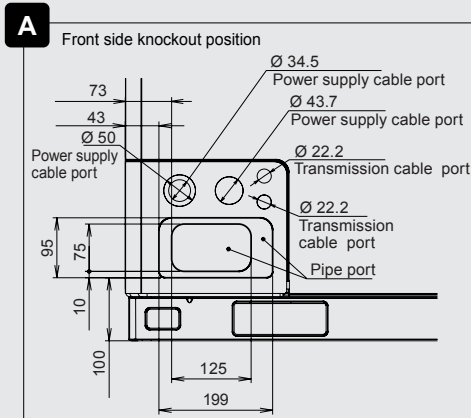
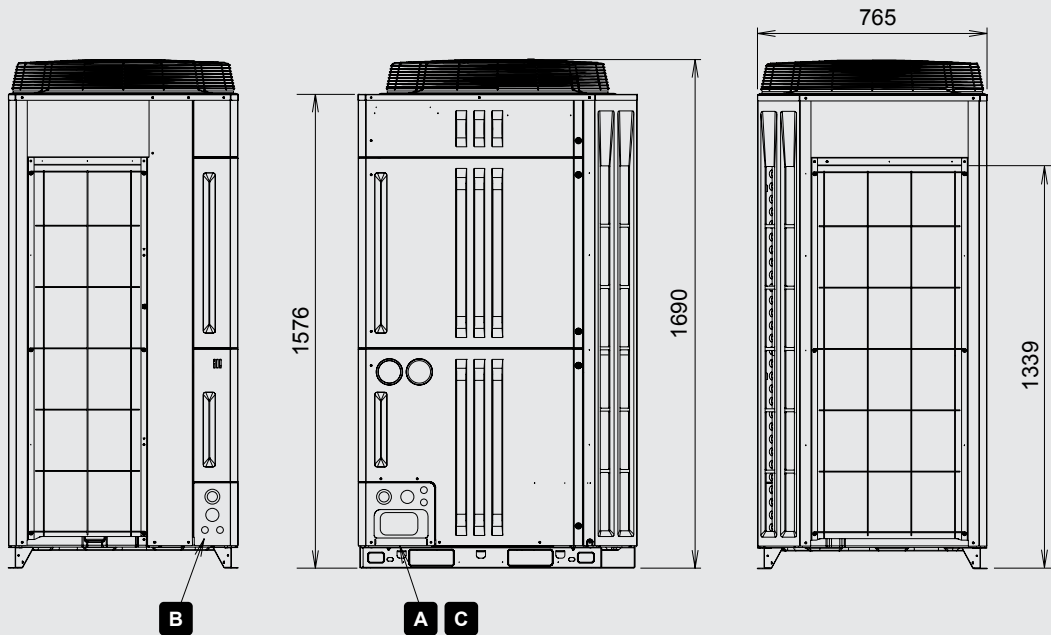
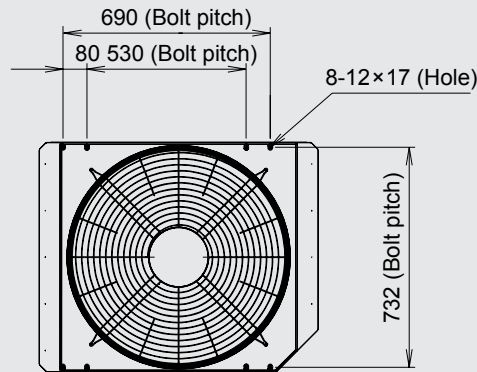

AJ* : AJY(FUJITSU), AJH(GENERAL)

14, 16HP

(Unit : mm)

AJ*126LALH / AJ*144LALH

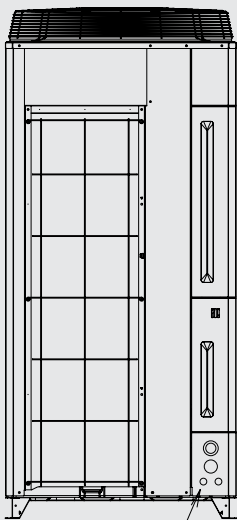
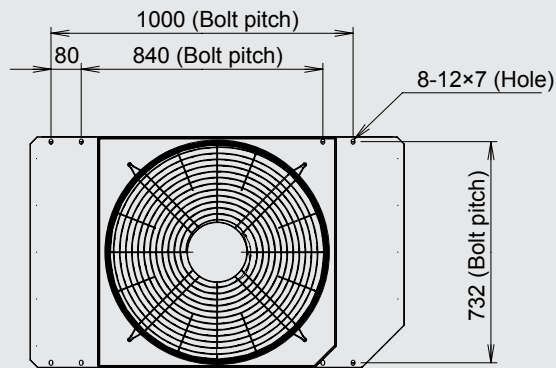



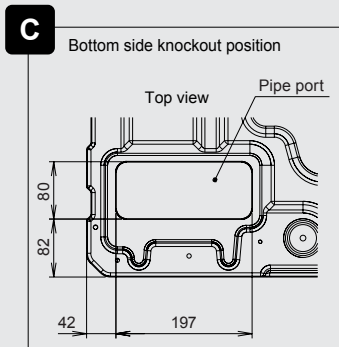
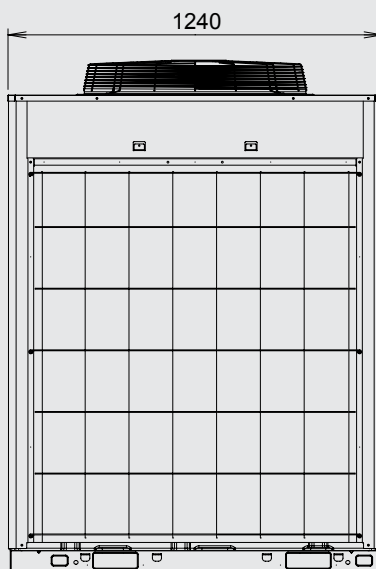
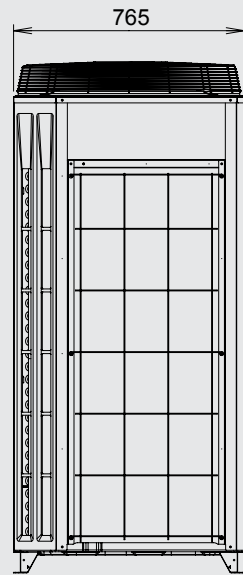
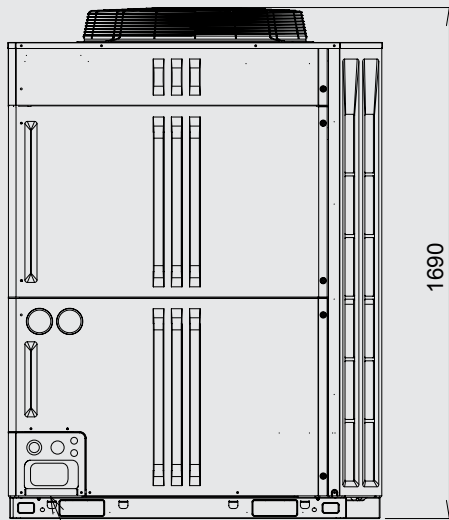





























B



Indoor Unit Lineup



































11 Types, 51 Models, Capacity range from 2.2kW to 25.0kW

Capacity range (kW)		2.2	2.8	3.6	4.5
Model code		7	9	12	14
Cassette	Compact Cassette	 AUXB07GALH	 AUXB09GALH	 AUXB12GALH	 AUXB14GALH
	Cassette				
Duct	Low Static Pressure Duct	 ARXB07GALH	 ARXB09GALH	 ARXB12GALH	 ARXB14GALH
	Slim Duct (Drain pump internal)	 ARXD07GALH	 ARXD09GALH	 ARXD12GALH	 ARXD14GALH
	Medium Static Pressure Duct				
	High Static Pressure Duct				
Floor	Floor (*Same as Ceiling models)			 AB*A12GATH	 AB*A14GATH
	Concealed Floor (*Same as Low Static Pressure Duct models)	 ARXB07GALH	 ARXB09GALH	 ARXB12GALH	 ARXB14GALH
	Slim Concealed Floor (*Same as Slim Duct models)	 ARXD07GALH	 ARXD09GALH	 ARXD12GALH	 ARXD14GALH
Ceiling	Ceiling			 AB*A12GATH	 AB*A14GATH
Wall Mounted	Wall Mounted	 AS*A07GACH	 AS*A09GACH	 AS*A12GACH	 AS*A14GACH
	Wall Mounted (EEV external)	 AS*E07GACH	 AS*E09GACH	 AS*E12GACH	 AS*E14GACH

With this model, connection of EV kit is necessary.

AB* : ABY(FUJITSU), ABH(GENERAL) AS* : ASY(FUJITSU), ASH(GENERAL)

Comprehensive range of indoor units of variety design and capacity ranges available which can be selected to suit any air conditioning needs.

5.6 18	7.1 24	9.0 30	11.2 36	12.5 45	14.0 54	18.0 60	22.4 72	25.0 90
 AUXB18GALH	 AUXB24GALH							
 AUXD18GALH	 AUXD24GALH	 AUXA30GALH	 AUXA36GALH	 AUXA45GALH	 AUXA54GALH			
 ARXB18GALH								
 ARXD18GALH	 ARXD24GALH							
	 ARXA24GBLH	 ARXA30GBLH	 ARXA36GBLH	 ARXA45GBLH				
			 ARXC36GATH	 ARXC45GATH		 ARXC60GATH	 ARXC72GATH	 ARXC90GATH
 AB*A18GATH	 AB*A24GATH							
 ARXB18GALH								
 ARXD18GALH	 ARXD24GALH							
 AB*A18GATH	 AB*A24GATH	 AB*A30GATH	 AB*A36GATH	 AB*A45GATH	 AB*A54GATH			
 AS*A18GACH	 AS*A24GACH	 AS*A30GACH						

Compact Cassette

Models

- AUXB07GALH**
- AUXB09GALH**
- AUXB12GALH**
- AUXB14GALH**
- AUXB18GALH**
- AUXB24GALH**



Compact size panel design that fits standard ceiling panel (600x600mm)

2-stage turbo fan

High efficiency design by 2 stage structure

An evenly spread air distribution across the heat exchanger is possible due to the new 2 stage turbo fan which produces two separate airflow streams.

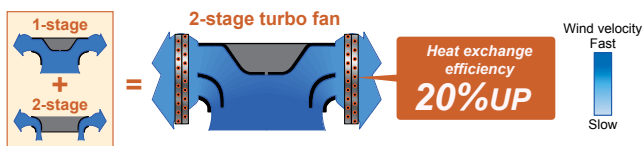

Previous turbo fan

In the case of a previous fan, the air outlet range was narrow as the airflow moved to the motor side which meant the velocity of air passing through the heat exchanger was uneven.



Quiet quality

Optimization of wing form (laminar wing type) and wing number (7 blades each)

Designed by CFD-analysis (fluid) simulations

Adoption of laminar wing

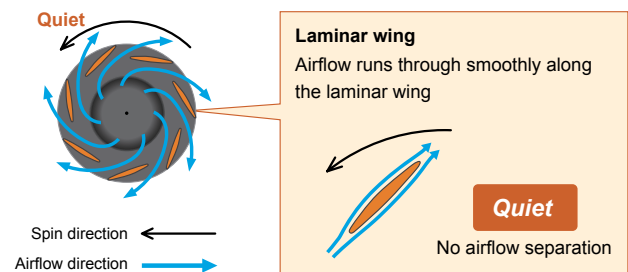

Specifications

Model name			AUXB07GALH	AUXB09GALH	AUXB12GALH	AUXB14GALH	AUXB18GALH	AUXB24GALH
Power source			230V ~, 50Hz					
Capacity	Cooling	kW	2.2	2.8	3.6	4.5	5.6	7.1
	Heating		2.8	3.2	4.1	5.0	6.3	8.0
Input power		W	25	25	29	35	36	84
Airflow rate	High	m³/h	540	550	600	680	710	1,030
	Med		450	450	530	590	580	830
	Low		350	350	390	390	400	450
Sound pressure level	High	dB(A)	34	35	37	38	41	50
	Med		30	30	34	34	35	44
	Low		25	25	27	27	27	30
Dimensions (H x W x D)		mm	245 x 570 x 570					
Weight		kg	15				17	
Connection pipe diameter	Liquid (Flare)	mm	ø6.35				ø9.52	
	Gas (Flare)		ø12.70				ø15.88	
	Drain		ø25 (I.D.) ; ø32 (O.D.)					
Cassette Grille	Model name		UTG-UF*C-W					
	Dimensions (H x W x D)		50 x 700 x 700					
	Weight		2.6					

F* : FY (FUJITSU) ; FG(GENERAL)

Note : Specifications are based on the following conditions.

Cooling : Indoor temperature of 27°CDB / 19°CWB, and outdoor temperature of 35°CDB / 24°CWB.

Heating : Indoor temperature of 20°CDB / (15°CWB), and outdoor temperature of 7°CDB / 6°CWB.

Pipe length : 7.5 m; Height difference between outdoor unit and indoor unit : 0 m. Voltage : 230 [V].

Improvement of the airflow distribution

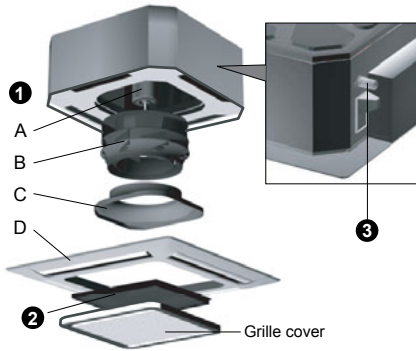

1 Maintenance of fan motor and fan

Maintenance of the fan motor and fan can be done easily after taking off the panel as the bell mouth of the fan can be removed easily.

A : Fan motor B : 2-stage turbo fan
C : Bell-mouth D : Panel

2 Long life filter : standard equipment

3 Adaptation of transparent drainage parts

During installation, maintenance and operation, the drain pump and kit can be checked easily.

High lift drain pump

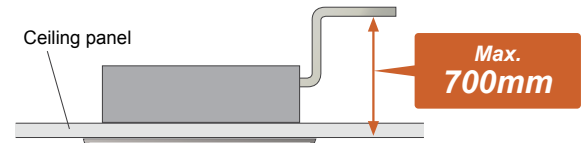

High ceiling mode

The compact cassette can be installed up to a height of 3.0m (12/14/18/24).

Model code	The maximum height from floor to ceiling (m)	
	Standard mode	High ceiling mode
07	2.7	—
09	2.7	—
12	2.7	3.0
14	2.7	3.0
18	2.7	3.0
24	2.7	3.0

Compact design

Worlds first 24,000Btu model in the compact cassette category (Easy installation by taking off ceiling panel of 600 x 600 size)



Optional parts

Air Outlet Shutter Plate : UTR-YDZB
Insulation Kit for High Humidity : UTZ-KXGC
Fresh Air Intake Kit : UTZ-VXAA

Dimensions (Unit : mm)

Models: AUXB07 / AUXB09 / AUXB12 / AUXB14 / AUXB18 / AUXB24

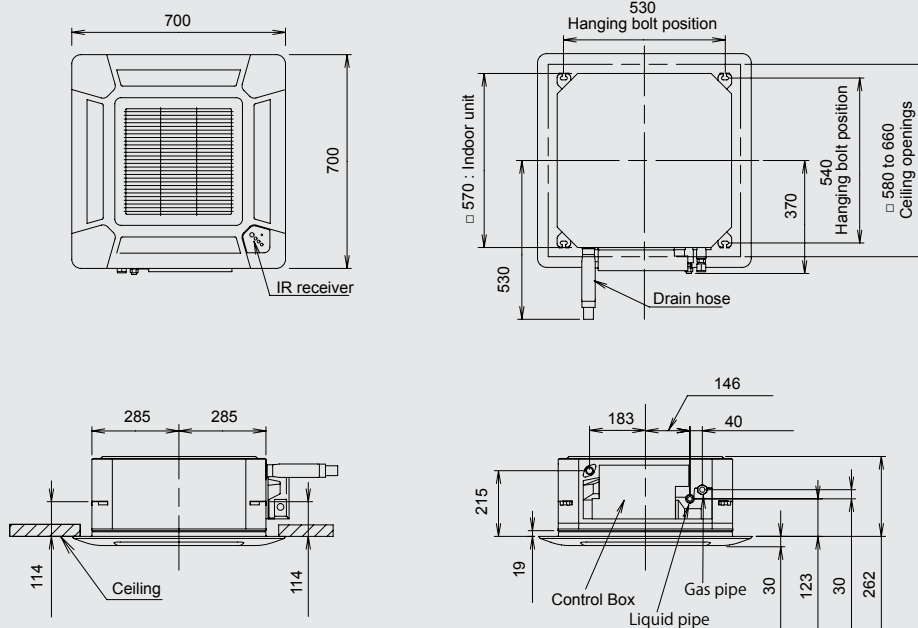

Cassette

Models

- AUXD18GALH
- AUXD24GALH
- AUXA30GALH
- AUXA36GALH
- AUXA45GALH
- AUXA54GALH



Powerful, wide airflow and quiet operation

High efficiency turbo fan with 3-dimensional blade

High efficiency airflow distribution has been achieved by the introduction of a 3 dimensional blade which increases the air passing over the heat exchanger.

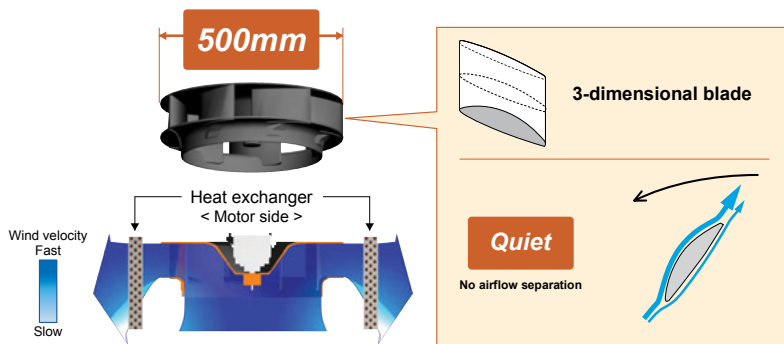

Previous turbo fan

Air passing through the heat exchanger was uneven and the air would only flow close to the ceiling.

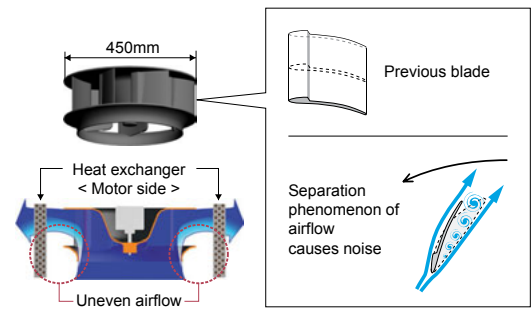

← : Spin direction → : Airflow direction ••••• : Turbulent flow noise

Specifications

Model name			AUXD18GALH	AUXD24GALH	AUXA30GALH	AUXA36GALH	AUXA45GALH	AUXA54GALH
Power source			230V ~, 50Hz					
Capacity	Cooling	kW	5.6	7.1	9.0	11.2	12.5	14.0
	Heating		6.3	8.0	10.0	12.5	14.0	16.0
Input power		W	39	46	59	80	99	119
Airflow rate	High	m³/h	1,150	1,280	1,600	1,800	1,900	2,000
	Med		940	1,040	1,300	1,300	1,370	1,370
	Low		870	870	1,100	1,100	1,100	1,100
Sound pressure level	High	dB(A)	36	38	40	44	46	47
	Med		30	33	38	38	39	39
	Low		29	29	33	33	33	33
Dimensions (H x W x D)		mm	246 x 840 x 840			288 x 840 x 840		
Weight		kg	22			27		
Connection pipe diameter	Liquid (Flare)	mm	ø9.52					
	Gas (Flare)		ø15.88			ø19.05		
	Drain		ø25 (I.D.) ; ø32 (O.D.)					
Cassette Grille	Model name		UTG-UG*A-W					
	Dimensions (H x W x D)		50 x 950 x 950					
	Weight		5.5					

G* : GY(FUJITSU) ; GG(GENERAL)

Note : Specifications are based on the following conditions.

Cooling : Indoor temperature of 27°CDB / 19°CWB, and outdoor temperature of 35°CDB / 24°CWB.

Heating : Indoor temperature of 20°CDB / (15°CWB), and outdoor temperature of 7°CDB / 6°CWB.

Pipe length : 7.5 m; Height difference between outdoor unit and indoor unit : 0 m. Voltage : 230 [V].

Improvement of the airflow distribution

The louvre design distributes air leaving a space between the chassis and the ceiling allowing far and wide air flow distribution.

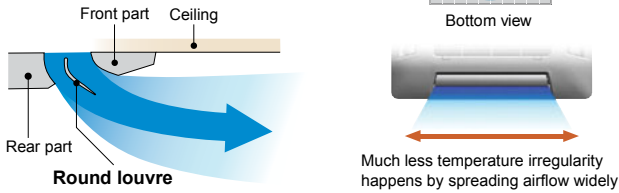

Adjustment of hanger position is possible after installation

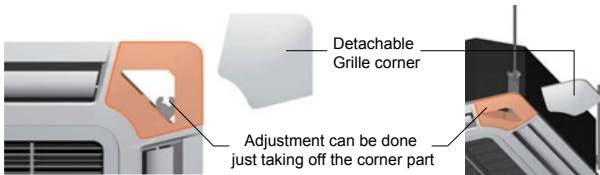

One way aperture installation

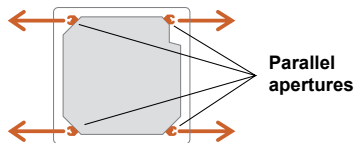

Dimensions (Unit : mm) () : AUXD18 / AUXD24

Models: AUXD18 / AUXD24 (Slim type)
AUXA30 / AUXA36 / AUXA45 / AUXA54

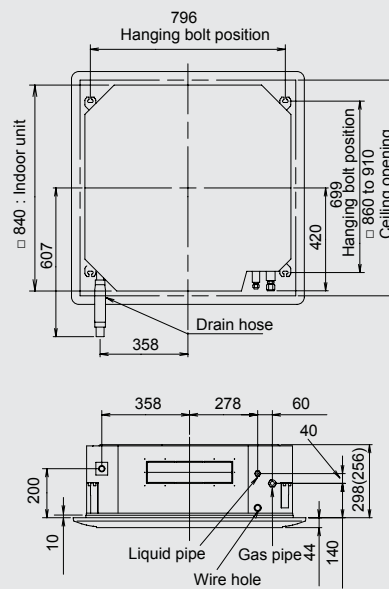
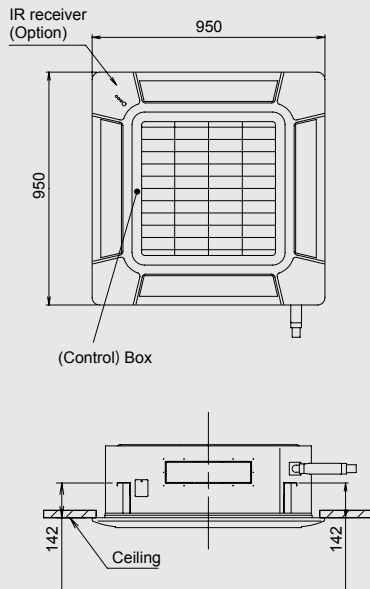

High lift drain pump

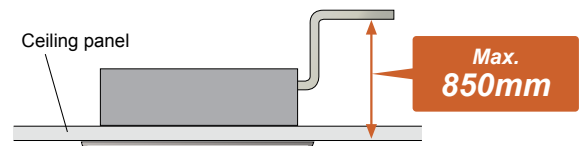

High ceiling mode

This cassette can be installed up to a height of 4.2m (36/45/54).

Model code	The maximum height from floor to ceiling (m)	
	Standard mode	High ceiling mode
18	3.0	3.5
24	3.0	3.5
30	3.2	3.6
36	3.2	4.2
45	3.2	4.2
54	3.2	4.2

Optional parts

IR Receiver Unit : UTY-LRH*B1
Air Outlet Shutter Plate : UTR-YDZC
Panel Spacer : UTG-BGYA-W
Insulation Kit for High Humidity : UTZ-KXGA / UTZ-KXGB
Wide Panel : UTG-AGYA-W
Fresh Air Intake Kit : UTZ-VXGA
H*: HY(FUJITSU), HG(GENERAL)

Low Static Pressure Duct / Concealed Floor

Models

- ARXB07GALH**
- ARXB09GALH**
- ARXB12GALH**
- ARXB14GALH**
- ARXB18GALH**



ARXB07GALH
ARXB09GALH



ARXB12GALH
ARXB14GALH
ARXB18GALH

Small and compact indoor unit suitable for many applications

Concealed Floor



Low noise level

A low noise level has been achieved for each capacity

Model		7	9	12	14	18
Static pressure range	Pa	0 to 50				
Noise level (Low speed)	dB(A)	24	27	25	30	30

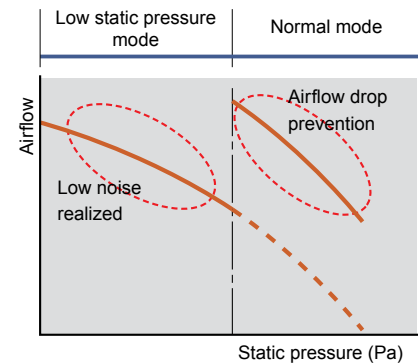

Specifications

Model name			ARXB07GALH	ARXB09GALH	ARXB12GALH	ARXB14GALH	ARXB18GALH	
Power source			230V ~, 50Hz					
Capacity	Cooling	kW	2.2	2.8	3.6	4.5	5.6	
	Heating		2.8	3.2	4.0	5.0	6.3	
Input power		W	46	55	63	90	96	
Airflow rate	High	m ³ /h	370	440	590	800	890	
	Med		310	370	500	750	810	
	Low		280	340	450	700	730	
Static pressure range		Pa	0 to 50	0 to 50	0 to 50	0 to 50	0 to 50	
Standard static pressure			25	25	25	25	25	
Sound pressure level	High	dB(A)	29	31	30	33	36	
	Med		26	29	28	32	34	
	Low		24	27	25	30	30	
Dimensions (H x W x D)		mm	217 x 663 x 595			217 x 953 x 595		
Weight		kg	15			22	23	
Connection pipe diameter	Liquid (Flare)	mm	ø6.35				ø9.52	
	Gas (Flare)		ø12.70				ø15.88	
	Drain		ø25 (I.D.) ; ø32 (O.D.)					

Note : Specifications are based on the following conditions.

Cooling : Indoor temperature of 27°CDB / 19°CWB, and outdoor temperature of 35°CDB / 24°CWB.
 Heating : Indoor temperature of 20°CDB / (15°CWB), and outdoor temperature of 7°CDB / 6°CWB.
 Pipe length : 7.5 m; Height difference between outdoor unit and indoor unit : 0 m.

Compact design

Ultra-slim duct air conditioner for easy installation

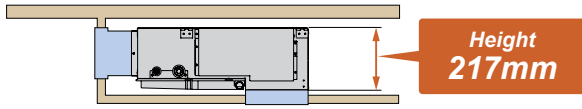

Slim size (217mm) allows installation even where the space behind the ceiling is narrow.

Two-direction drain piping

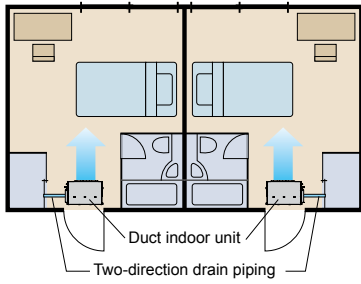

Air-intake

Air intake direction can be selected to match the installation site.

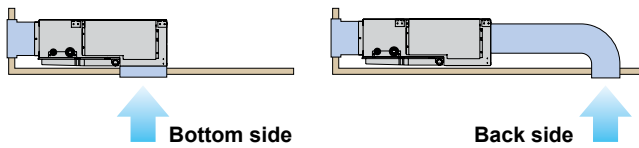

Flexible installation

Ceiling concealed

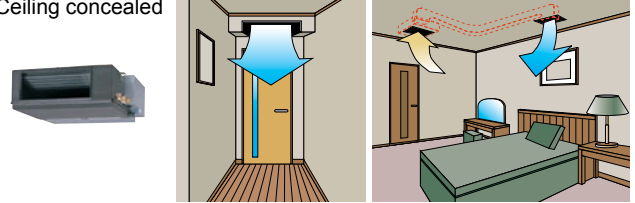

Floor concealed

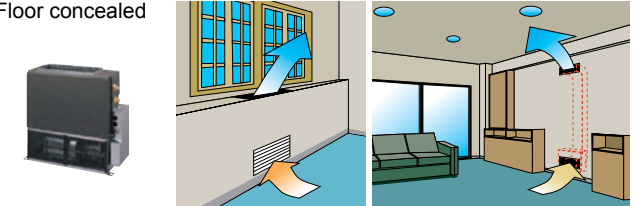

Filter (Accessory)

ARXB07 / ARXB09

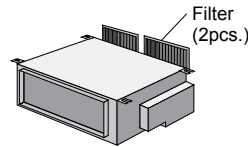

ARXB12 / ARXB14 / ARXB18

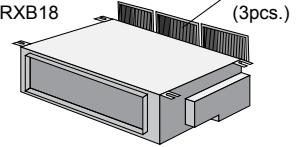

Optional parts

Remote Sensor Unit : UTY-XSZX

IR Receiver Unit : UTB-YWC

Drain Pump Unit : UTZ-PX1BBA

Dimensions (Unit : mm) () : AR7 / AR9

Models: ARXB07 / ARXB09 / ARXB12 / ARXB14 / ARXB18

*Service accessibility must be allowed for when installing the product.
Please consult the installation manual for the necessary service access size.

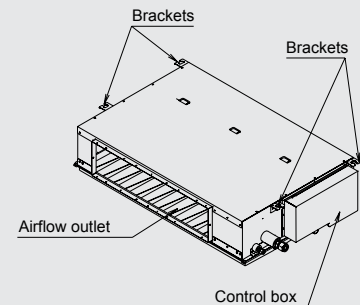
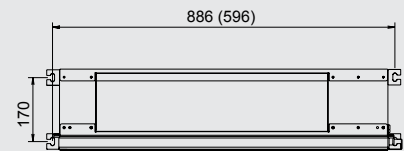
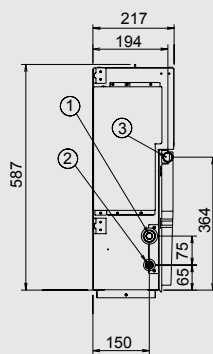
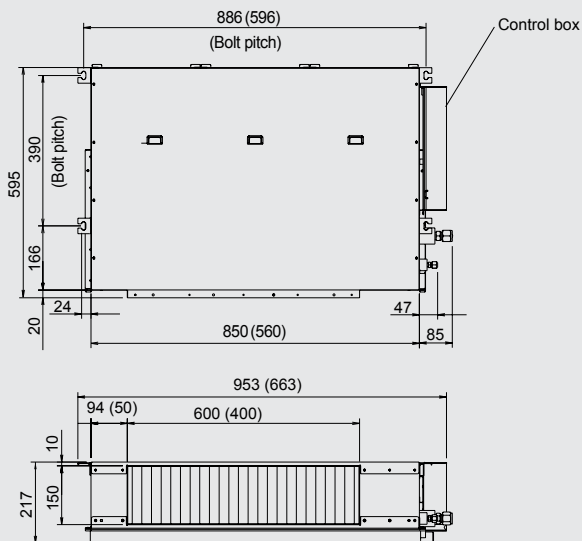

- ① Refrigerant piping flare connection (Gas)
- ② Refrigerant piping flare connection (Liquid)
- ③ Drain piping connection

Slim Duct / Slim Concealed Floor

Models (Drain pump internal model)

- ARXD07GALH**
- ARXD09GALH**
- ARXD12GALH**
- ARXD14GALH**
- ARXD18GALH**
- ARXD24GALH**



Slim design and wide range of static pressure for flexible installation.

Slim Concealed Floor



Slim design

This model is slim design, it can install at the place where a ceiling is narrow.

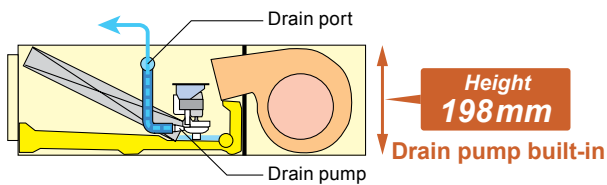

Air-intake

Air intake direction can be selected to match the installation site.

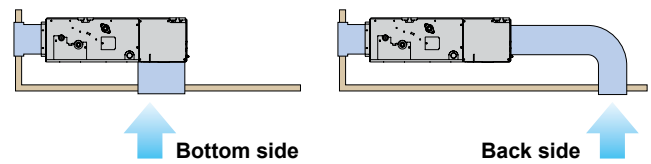

Specifications

Model name			ARXD07GALH	ARXD09GALH	ARXD12GALH	ARXD14GALH	ARXD18GALH	ARXD24GALH
Power source			230V ~, 50Hz					
Capacity	Cooling	kW	2.2	2.8	3.6	4.5	5.6	7.1
	Heating		2.8	3.2	4.0	5.0	6.3	8.0
Input power		W	44	50	54	92	83	122
Airflow rate	High	m ³ /h	550	600	600	800	940	1,330
	Med		490	550	510	710	840	1,240
	Low		440	480	450	610	750	1,100
Static pressure range		Pa	0 to 90	0 to 90	0 to 90	0 to 90	0 to 90	0 to 50
Standard static pressure			25	25	25	25	25	25
Sound pressure level	High	dB(A)	28	29	30	34	34	35
	Med		25	26	27	32	32	32
	Low		22	24	24	28	28	29
Dimensions (H x W x D)		mm	198 x 700 x 620				198 x 900 x 620	198 x 1,100 x 620
Weight		kg	17		18		22	26
Connection pipe diameter	Liquid (Flare)	mm	ø6.35				ø9.52	
	Gas (Flare)		ø12.70				ø15.88	
	Drain		ø25 (I.D.) ; ø32 (O.D.)					

Note : Specifications are based on the following conditions.

Cooling : Indoor temperature of 27°CDB / 19°CWB, and outdoor temperature of 35°CDB / 24°CWB.
 Heating : Indoor temperature of 20°CDB / (15°CWB), and outdoor temperature of 7°CDB / 6°CWB.
 Pipe length : 7.5 m; Height difference between outdoor unit and indoor unit : 0 m.

High lift drain pump

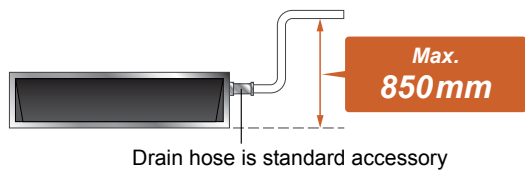

Selectable with a wide range of static pressure

By using DC fan motor, it is possible to change of static pressure range 0 to 90Pa.

The change of static pressure range is possible by remote controller.



Static pressure range
0 to 90 Pa

*24 model is 0 to 50Pa

Flexible installation

Ceiling concealed

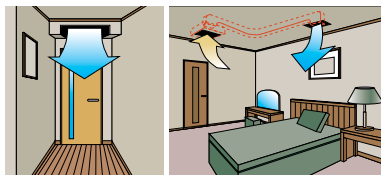

Floor concealed

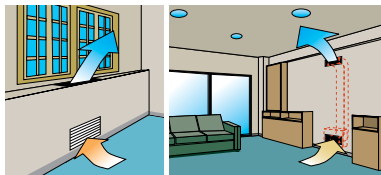

Auto Louver Grille Kit (Option)

Simple flat Auto Louver will provide comfort airflow and harmonize with luxury interior.

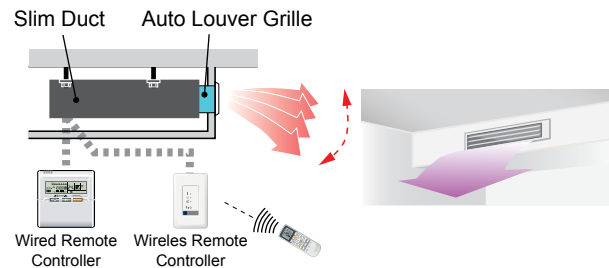

Filter (Accessory)

ARXD07 / 09 / 12 / 14 / 18

Filter (2pcs.)

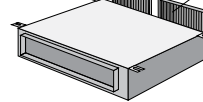

ARXD24

Filter (3pcs.)

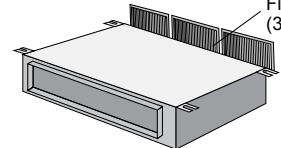

Optional parts

Remote Sensor Unit : UTY-XSZX

IR Receiver Unit : UTB-YWC

Auto Louver Grille Kit : UTD-GXSA-W (for ARXD07/09/12/14GALH)

UTD-GXSB-W (for ARXD18GALH)

UTD-GXSC-W (for ARXD24GALH)

Dimensions (Unit : mm)

Models: ARXD07 / ARXD09 / ARXD12 / ARXD14 / ARXD18 / ARXD24

*Service accessibility must be allowed for when installing the product.

Please consult the installation manual for the necessary service access size.

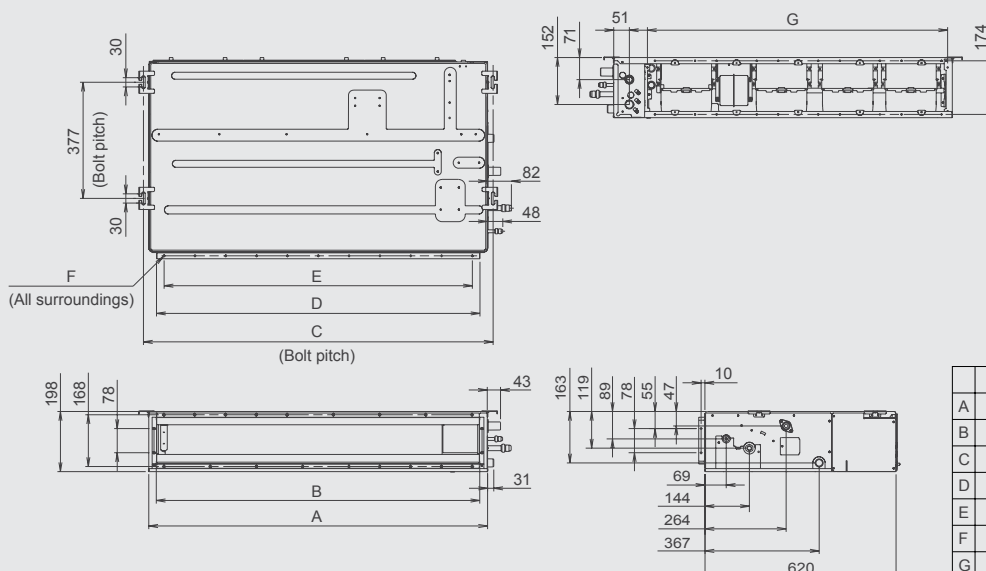

	ARXD07-14	ARXD18	ARXD24
A	700	900	1100
B	650	850	1050
C	734	934	1134
D	650	850	1050
E	P100x6=600	P100x8=800	P100x10=1000
F	18xØ5	22xØ5	26xØ5
G	574	774	974

Medium Static Pressure Duct

Models

- ARXA24GBLH**
- ARXA30GBLH**
- ARXA36GBLH**
- ARXA45GBLH**

Low energy consumption by DC fan motor.
Selectable with a wide range of static pressure.



Slim & Compact design

In the case of bottom return air connection, not only does the indoor unit design allow for installation in a narrow ceiling space of up to 270mm, Further space savings have been achieved by mounting the electrical control box internally inside the chassis.

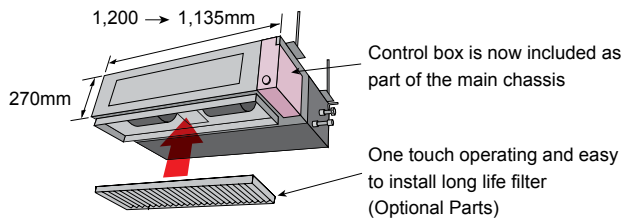

Low energy consumption by high efficiency DC fan motor

Improved motor efficiency from previous model.

NEW



24 model

NEW



30 / 36 / 45 model

Specifications

Model name			ARXA24GBLH	ARXA30GBLH	ARXA36GBLH	ARXA45GBLH
Power source			230V ~, 50Hz			
Capacity	Cooling	kW	7.1	9.0	11.2	12.5
	Heating		8.0	10.0	12.5	14.0
Input power		W	94	108	194	240
Airflow rate	High	m ³ /h	1,280	1,410	1,840	1,970
	Med		990	1,280	1,600	1,860
	Low		840	1,150	1,470	1,640
Static pressure range		Pa	0 to 150	0 to 150	0 to 150	0 to 150
Standard static pressure			40	50	50	60
Sound pressure level	High	dB(A)	31	34	37	41
	Med		27	32	35	38
	Low		23	29	33	36
Dimensions (H x W x D)		mm	270 x 1,135 x 700			
Weight		kg	36	40		
Connection pipe diameter	Liquid (Flare)	mm	ø9.52			
	Gas (Flare)		ø15.88		ø19.05	
	Drain		ø25 (I.D.) ; ø32 (O.D.)			

Note : Specifications are based on the following conditions.

Cooling : Indoor temperature of 27°CDB / 19°CWB, and outdoor temperature of 35°CDB / 24°CWB.
Heating : Indoor temperature of 20°CDB / (15°CWB), and outdoor temperature of 7°CDB / 6°CWB.
Pipe length : 7.5 m; Height difference between outdoor unit and indoor unit : 0 m.

Selectable with a wide range of static pressure

It is possible to change of static pressure range 0 to 150Pa.

**Static pressure range
0 to 150 Pa**

Can be installed for various location

It can be installed in such locations as high-rise condominiums by low static pressure design.

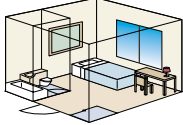

It can also be installed in wide spade when high static pressure is required, such as for offices.



Easy setting by using remote controller

The change of static pressure range is possible by remote controller

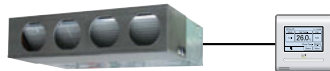

Two-direction drain piping

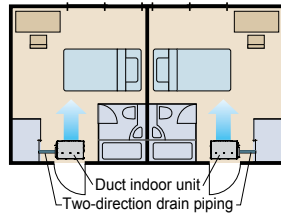

Easy maintenance

See below for the case of rear suction type

New model

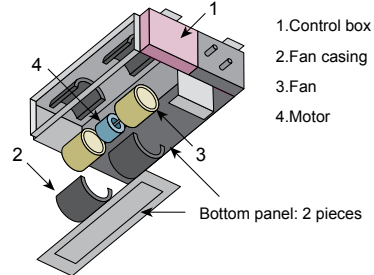

The maintenance of the motor and fan can be easily carried out by removing the rear panel and the lower part of the casing while leaving the main chassis installed.

Installation styles

Embedded in Ceiling

Hanging from Ceiling

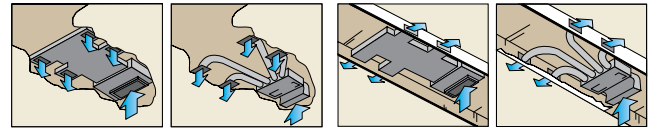

Optional parts

Remote Sensor Unit : UTY-XSZX Flange (Round) : UTD-RF204
 Long Life Filter : UTD-LF25NA IR Receiver Unit : UTB-YWC
 Flange (Square) : UTD-SF045T Drain Pump Unit : UTZ-PX1NBA

Dimensions (Unit : mm)

Models: ARXA24 / ARXA30 / ARXA36 / ARXA45

*Service accessibility must be allowed for when installing the product.
 Please consult the installation manual for the necessary service access size.

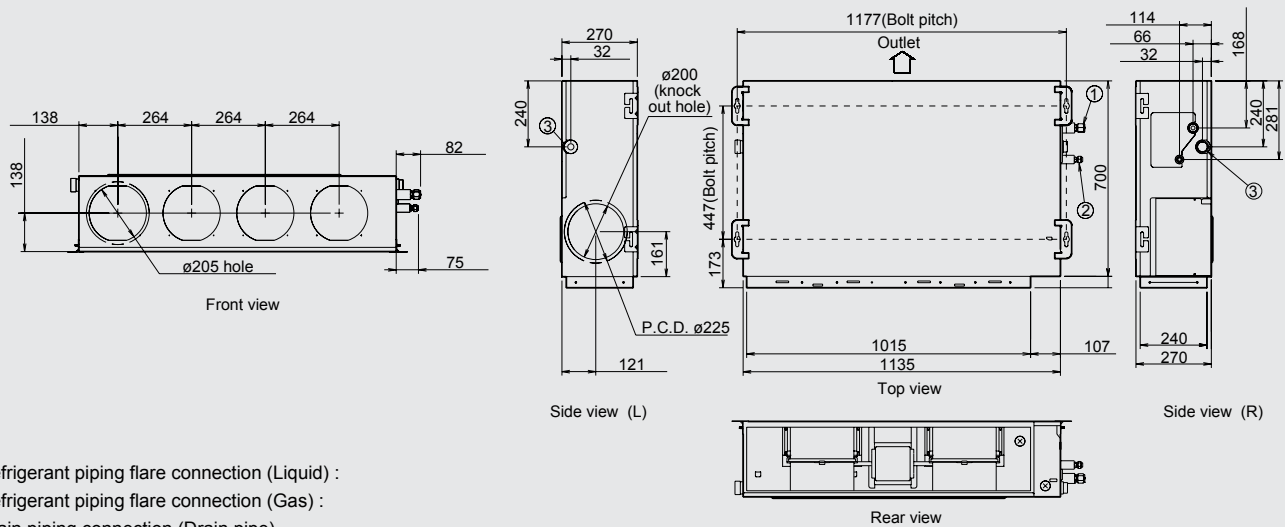

- ① Refrigerant piping flare connection (Liquid) :
- ② Refrigerant piping flare connection (Gas) :
- ③ Drain piping connection (Drain pipe)

High Static Pressure Duct

Models

- ARXC36GATH**
- ARXC45GATH**
- ARXC60GATH**
- ARXC72GATH**
- ARXC90GATH**

These indoor units allow for high airflow quantities



ARXC36GATH
ARXC45GATH
ARXC60GATH



ARXC72GATH
ARXC90GATH

Specifications

Model name			ARXC36GATH	ARXC45GATH	ARXC60GATH	ARXC72GATH	ARXC90GATH
Power source			230V ~, 50Hz				
Capacity	Cooling	kW	11.2	12.5	18.0	22.4	25.0
	Heating		12.5	14.0	20.0	25.0	28.0
Input power		W	405	715	730	1,110	1,250
Airflow rate	High	m ³ /h	2,600	3,500	3,500	3,900	4,300
	Med		1,950	3,000	3,000	3,300	4,000
	Low		1,450	2,460	2,460	3,000	3,500
Static pressure range		Pa	100 to 200	100 to 250	100 to 250	50 to 300	100 to 300
Standard static pressure			100	100	100	260	250
Sound pressure level	High	dB(A)	45	49	49	51	53
	Med		38	45	45	48	51
	Low		32	42	42	45	49
Dimensions (H x W x D)		mm	400 x 1,050 x 500			450 x 1,550 x 700	
Weight		kg	43	46		83	85
Connection pipe diameter	Liquid	mm	ø9.52 (Flare)			ø12.70 (Brazing)	
	Gas		ø19.05 (Flare)			ø22.22 (Brazing)	
	Drain		ø25 (I.D.) ; ø32 (O.D.)				

Note : Specifications are based on the following conditions.

Cooling : Indoor temperature of 27°CDB / 19°CWB, and outdoor temperature of 35°CDB / 24°CWB.
 Heating : Indoor temperature of 20°CDB / (15°CWB), and outdoor temperature of 7°CDB / 6°CWB.
 Pipe length : 7.5 m; Height difference between outdoor unit and indoor unit : 0 m.

Easy installation (Compact size & Lightweight)

Models : ARXC36

A compact size and lightweight indoor unit has been developed by reducing the basic chassis and the overall material weight.

Volume
47.5%
down

Weight
42%
down

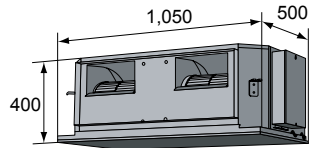

ARXC36GATH : 43kg (unit: mm)

Static pressure selection

Models : ARXC72 / ARXC90

2 Types of static pressure mode are selectable.

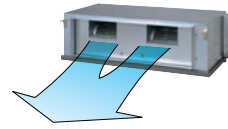

Max.
300Pa

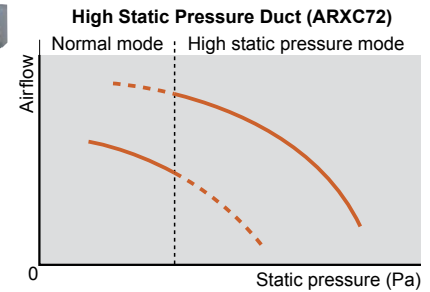

The adoption of a single phase fan motor allows 3 steps fan speed control

Low noise

Models : ARXC36 / ARXC45 / ARXC60

Cutting off the corners of the conventional indoor unit front panel and fan casing, has enabled less turbulent air flow. Low noise is realized by adopting a plastic case and a plastic fan.

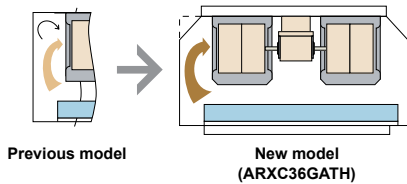

ARXC36GATH : Plastic fan [45dB(A)]

* Model : Material
(At 100Pa : Actual noise measurement value)

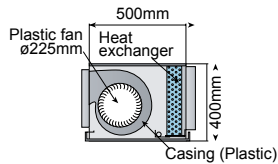

Optional parts

Long-Life Filter : UTD-LF60KA (For ARXC36 / 45 / 60)
IR Receiver Unit : UTB-YWC
Remote Sensor Unit : UTY-XSZX

Dimensions (Unit : mm)

Models: ARXC36 / ARXC45 / ARXC60

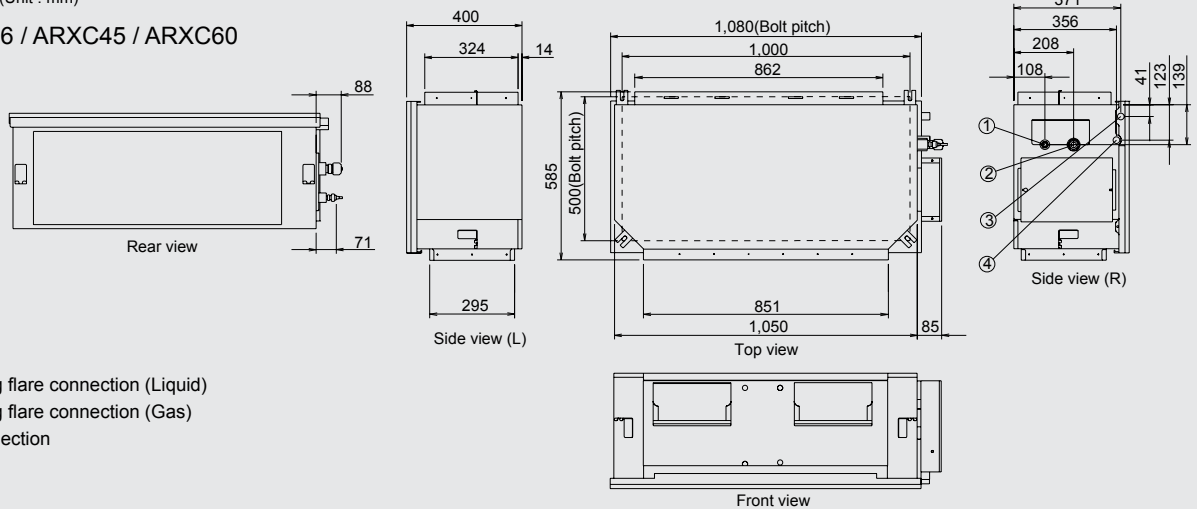

Models: ARXC72 / ARXC90

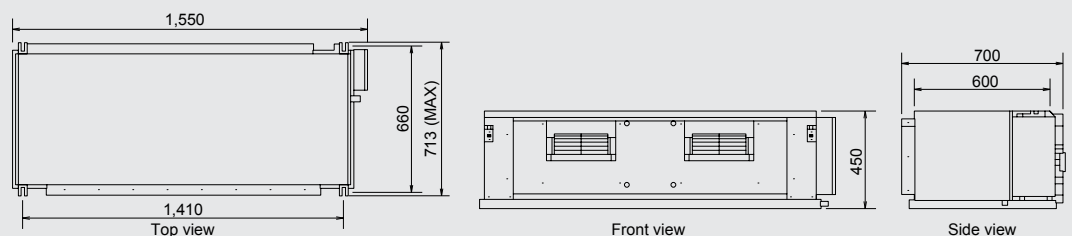

Floor / Ceiling

Models

- AB*A12GATH**
- AB*A14GATH**
- AB*A18GATH**
- AB*A24GATH**

The slim and lightweight design allow the unit to be suspended from the ceiling or installed on the floor. This type suits many room designs



Floor standing



Flexible installation

Example for floor installation

Floor console



Example for ceiling installation

Under ceiling



Specifications

Model name			AB*A12GATH	AB*A14GATH	AB*A18GATH	AB*A24GATH
Power source			230V ~, 50Hz			
Capacity	Cooling	kW	3.6	4.5	5.6	7.1
	Heating		4.0	5.0	6.3	8.0
Input power		W	30	42	74	99
Airflow rate	High	m³/h	660	780	1,000	1,000
	Med		570	640	720	820
	Low		490	550	580	680
Sound pressure level	High	dB(A)	36	40	46	47
	Med		32	36	39	42
	Low		28	34	35	37
Dimensions (H x W x D)		mm	199 x 990 x 655			
Weight		kg	25	26	26	27
Connection pipe diameter	Liquid (Flare)	mm	ø6.35		ø9.52	
	Gas (Flare)		ø12.70		ø15.88	
	Drain		ø25 (I.D.) ; ø32 (O.D.)			

AB*: ABY(FUJITSU), ABH(GENERAL)

Note : Specifications are based on the following conditions.

Cooling : Indoor temperature of 27°CDB / 19°CWB, and outdoor temperature of 35°CDB / 24°CWB.

Heating : Indoor temperature of 20°CDB / (15°CWB), and outdoor temperature of 7°CDB / 6°CWB.

Pipe length : 7.5 m; Height difference between outdoor unit and indoor unit : 0 m.

Voltage : 230 [V].

Double auto swing

A combination of up/down and right/left directional swing allows three-dimensional air direction control.

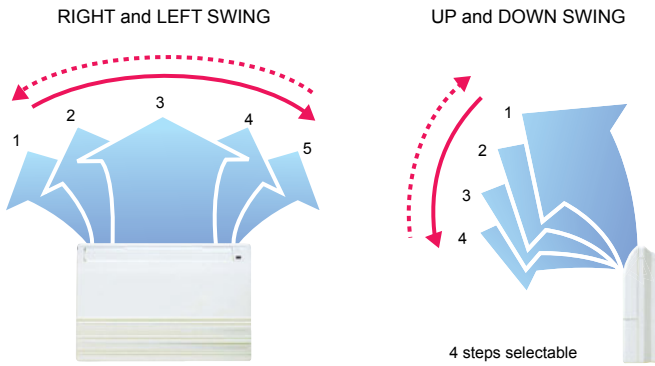

Super vane

Double Louvre Super vane with newly developed special configuration boosts airflow sending cool air quickly to every corner of the room.

Auto-closing louvre

When operation is stopped, the louvres will automatically close. (This function is available on all non-ducted models.)

Compact design

Symmetrical, slim and compact design.

High power DC fan motor

- High power
- Wide rotation range
- High efficiency

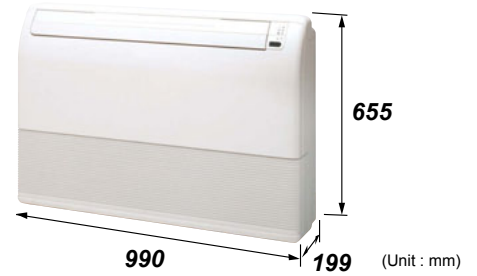
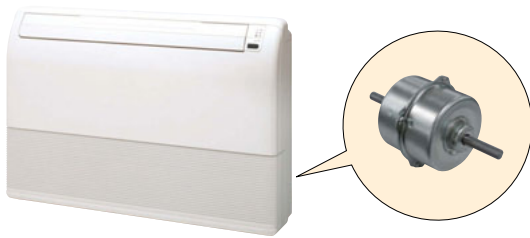

Dimensions (Unit : mm)

Models: AB*A12 / AB*A14 / AB*A18 / AB*A24

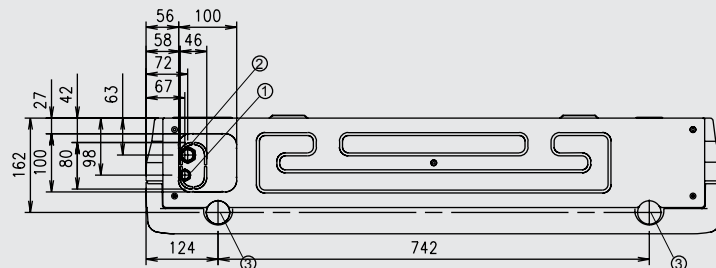
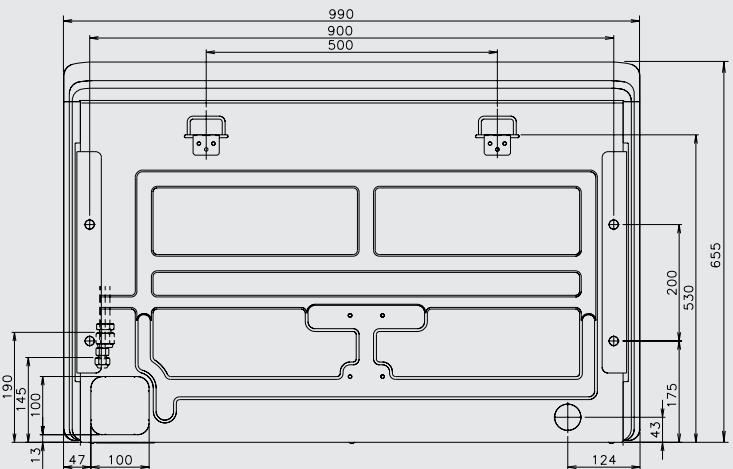
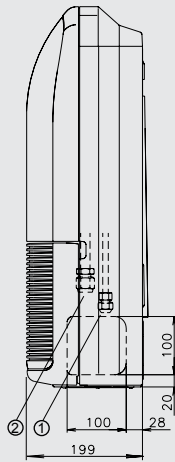

- ① Refrigerant piping flare connection (Liquid)
- ② Refrigerant piping flare connection (Gas)
- ③ Drain piping connection

Ceiling

Models

- AB*A30GATH**
- AB*A36GATH**
- AB*A45GATH**
- AB*A54GATH**

Easily concealed in any installation



Installation

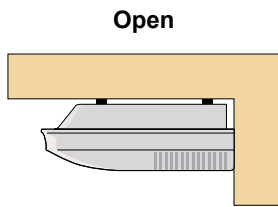

General installation pattern which suspends the indoor unit from the ceiling.

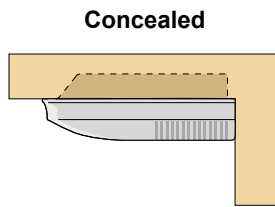

Installation pattern where part of the indoor unit is embedded into the ceiling.

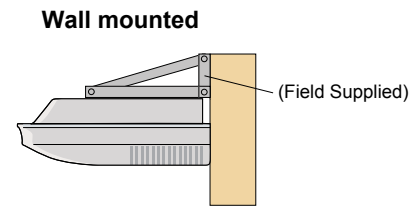

Installation which fixes the indoor unit to the wall by the use of wall brackets (Field supplied). This type of installation can be used when the ceiling space is insufficient.

Specifications

Model name			AB*A30GATH	AB*A36GATH	AB*A45GATH	AB*A54GATH
Power source			230V ~, 50Hz			
Capacity	Cooling	kW	9.0	11.2	12.5	14.0
	Heating		10.0	12.5	14.0	16.0
Input power		W	66	85	131	180
Airflow rate	High	m³/h	1,630	1,690	2,010	2,270
	Med		1,370	1,400	1,600	1,780
	Low		1,140	1,170	1,230	1,280
Sound pressure level	High	dB(A)	42	45	48	51
	Med		38	38	42	45
	Low		33	34	35	36
Dimensions (H x W x D)		mm	240 x 1,660 x 700			
Weight		kg	46		48	
Connection pipe diameter	Liquid (Flare)	mm	ø9.52		ø9.52	
	Gas (Flare)		ø15.88		ø19.05	
	Drain		ø25 (I.D.) ; ø32 (O.D.)			

AB*: ABY(FUJITSU), ABH(GENERAL)

Note : Specifications are based on the following conditions.

Cooling : Indoor temperature of 27°CDB / 19°CWB, and outdoor temperature of 35°CDB / 24°CWB.

Heating : Indoor temperature of 20°CDB / (15°CWB), and outdoor temperature of 7°CDB / 6°CWB.

Pipe length : 7.5 m; Height difference between outdoor unit and indoor unit : 0 m.

Voltage : 230 [V].

Double auto swing and wide airflow

Auto airflow direction and auto swing

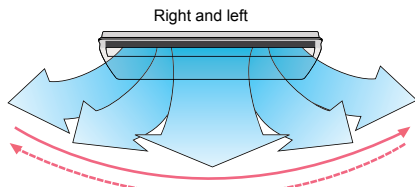

5 steps selectable

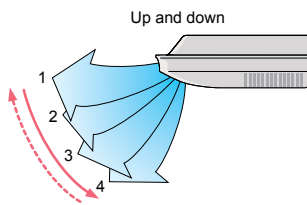

4 steps selectable

Long airflow

Long Airflow ensures comfort to every corner of a large room.

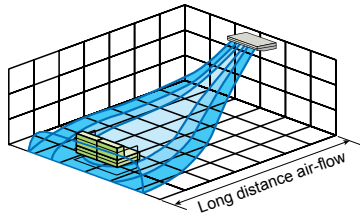

Slim & Compact design

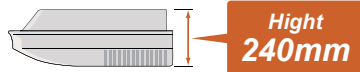

High lift drain pump

Optional drain pump unit allows flexible installation design.

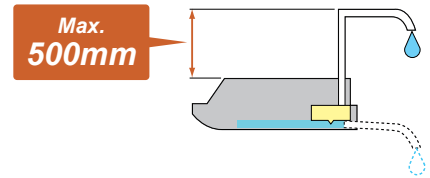

Fresh air intake

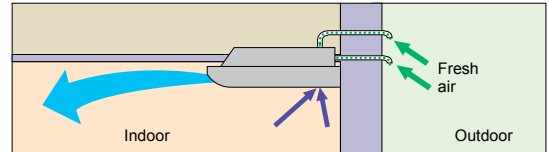

High power DC fan motor

- High power
- Wide rotation range
- High efficiency

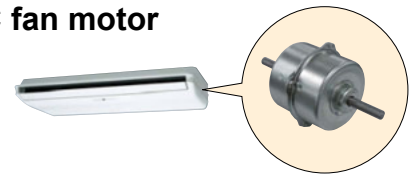

Long-life filter

High Efficiency long-life filter doubles the life of the filter compared to standard filters.

Optional parts

Drain Pump Unit : UTR-DPB24T
Flange : UTD-RF204

Dimensions (Unit : mm)

Models: AB*A30 / AB*A36 / AB*A45 / AB*A54

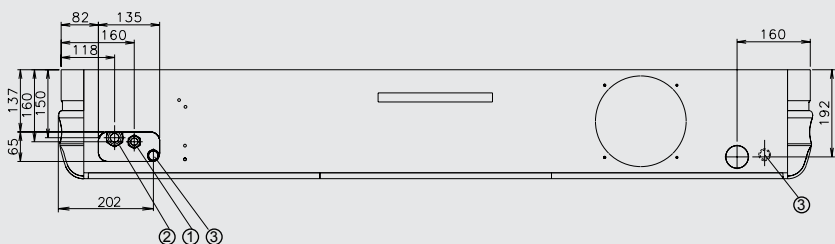
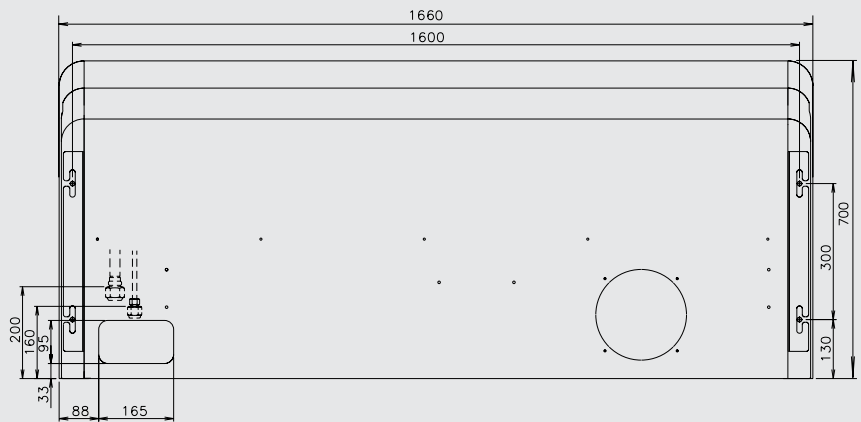
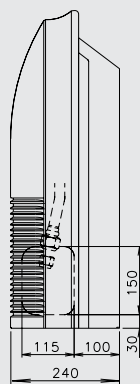

- ① Refrigerant piping flare connection (Liquid)
- ② Refrigerant piping flare connection (Gas)
- ③ Drain piping connection

Wall Mounted

Models (EEV internal model)

AS*A07GACH
AS*A09GACH
AS*A12GACH
AS*A14GACH

Models (EEV external model)

AS*E07GACH
AS*E09GACH
AS*E12GACH
AS*E14GACH



Compact and Stylish design indoor

Filter features

High quality air conditioning by incorporation of high performance filter.



Long-life* Ion Deodorization Filter

The filter deodorizes by powerfully decomposing absorbed odors using the oxidizing and reducing effects of ions generated by the ultra-fine-particle ceramic.

(*The filter can be used for approx. 3 years if it is washed under water to restore its surface action when it is dirty.)



Apple-catechin Filter

Fine dust, invisible mold spores, and harmful microorganisms are absorbed onto the filter by static electricity, and further growth is inhibited and deactivated by the polyphenol extracted from apples.

Deodorizing effect (Odor reduction rate)

Ammonia

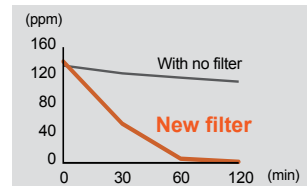

Trimethylamine

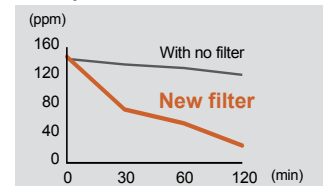

Hydrogen sulfate

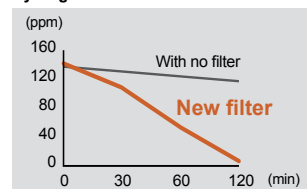

Testing organization :
 Environmental Sanitary Inspection Center
 Test method :
 Deodorization Test

Specifications

Model name		AS*A07GACH	AS*A09GACH	AS*A12GACH	AS*A14GACH	AS*E07GACH	AS*E09GACH	AS*E12GACH	AS*E14GACH	
Power source		230V ~, 50Hz				230V ~, 50Hz				
Capacity	Cooling	kW	2.2	2.8	3.6	4.5	2.2	2.8	3.6	4.5
	Heating		2.8	3.2	4.1	5.0	2.8	3.2	4.1	5.0
Input power		W	17	18	22	34	15	16	21	34
Airflow rate	High	m ³ /h	490	500	560	670	490	500	560	680
	Med		450	450	480	490	450	450	480	490
	Low		370/420*1	370/420*1	420	420	370/420*1	370/420*1	420	420
Sound pressure level	High	dB(A)	35	36	39	44	34	35	38	43
	Med		33	33	35	37	32	32	34	35
	Low		27/31*1	27/31*1	31	32	26/30*1	26/30*1	30	30
Dimensions (H x W x D)		mm	275 x 790 x 215				275 x 790 x 215			
Weight		kg	9				9			
Connection pipe diameter	Liquid (Flare)	mm	ø6.35				ø6.35			
	Gas (Flare)		ø12.70				ø12.70			
	Drain		ø13.8(I.D.) ; ø15.8-ø16.7(O.D.)				ø13.8(I.D.) ; ø15.8-ø16.7(O.D.)			
EV Kit (option)			—				UTR-EV09XB		UTR-EV14XB	

AS*: ASY(FUJITSU), ASH(GENERAL)

Note : Specifications are based on the following conditions.

Cooling : Indoor temperature of 27°CDB / 19°CWB, and outdoor temperature of 35°CDB / 24°CWB.

Heating : Indoor temperature of 20°CDB / (15°CWB), and outdoor temperature of 7°CDB / 6°CWB.

Pipe length : 7.5 m; Height difference between outdoor unit and indoor unit : 0 m.

Voltage : 230 [V].

*1 : This value is under cooling operation.

Compact size

Powerful output even compact design

Width
790mm

Though the indoor unit is compact, it features a large, high pressure cross fan (90mm diameter) in a centre mounted configuration and a Lambda type heat exchanger to provide plenty of power.

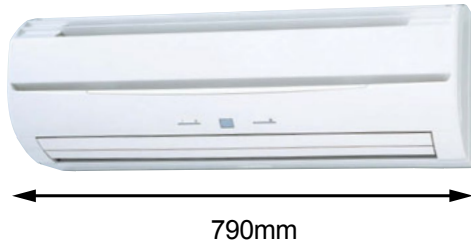

Auto swing louvre

The Auto Swing Louvre function ensures that the air direction corresponds to the mode selected.

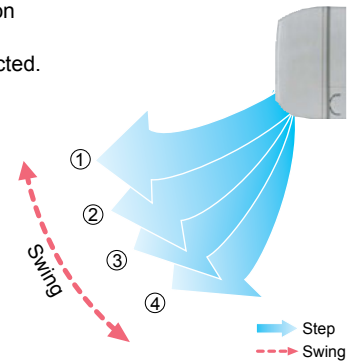

New style high power DC fan motor

- High power
- Wide rotation range
- High efficiency
- Compact size

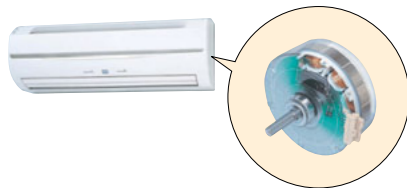

Easy maintenance

Easy maintenance has been realized as the front panel can be removed for easy access.



Symmetrical design

Symmetrical, clean design that suits all interiors.

Dimensions (Unit : mm)

Models: AS*A07 / AS*A09 / AS*A12 / AS*A14
AS*E07 / AS*E09 / AS*E12 / AS*E14

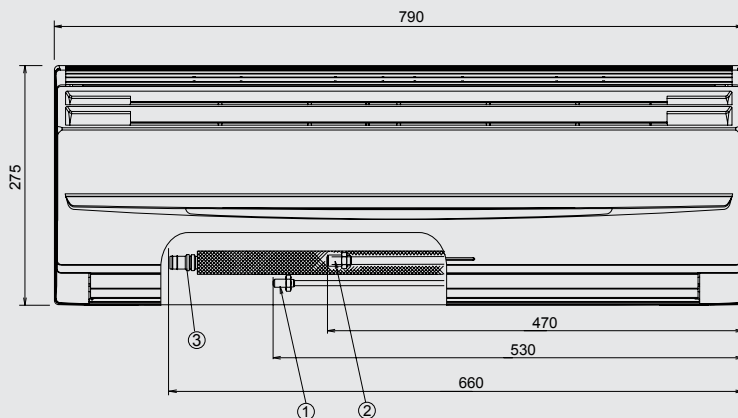

- ① Refrigerant pipe flare connection (Liquid)
- ② Refrigerant pipe flare connection (Gas)
- ③ Drain piping connection

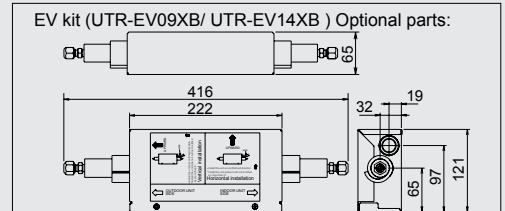
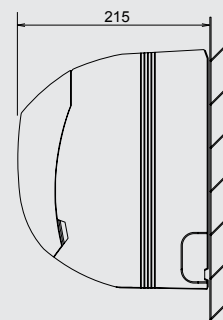

Wall Mounted

Models

- AS*A18GACH**
- AS*A24GACH**
- AS*A30GACH**

Simple & Elegant Appearance Design



Compact & Slim design

By using DC fan motor, compact design is realized.

New model



Previous model

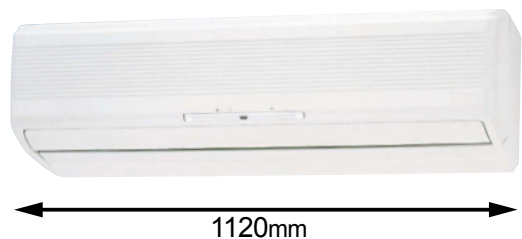

Specifications

Model name			AS*A18GACH	AS*A24GACH	AS*A30GACH
Power source			230V ~, 50Hz		
Capacity	Cooling	kW	5.6	7.1	8.0
	Heating		6.3	8.0	9.0
Input power		W	32	60	91
Airflow rate	High	m³/h	840	1,100	1,240
	Med		770	910	980
	Low		690	730	770
Sound pressure level	High	dB(A)	41	48	52
	Med		39	43	45
	Low		35	35	35
Dimensions (H x W x D)		mm	320 x 998 x 228		
Weight		kg	15		
Connection pipe diameter	Liquid (Flare)	mm	ø9.52		
	Gas (Flare)		ø15.88		
	Drain		ø12 (I.D.); ø16 (O.D.)		

AS*: ASY(FUJITSU), ASH(GENERAL)

Note : Specifications are based on the following conditions.

Cooling : Indoor temperature of 27°CDB / 19°CWB, and outdoor temperature of 35°CDB / 24°CWB.

Heating : Indoor temperature of 20°CDB / (15°CWB), and outdoor temperature of 7°CDB / 6°CWB.

Pipe length : 7.5 m; Height difference between outdoor unit and indoor unit : 0 m.

Voltage : 230 [V].

“Vertical airflow” provides powerful floor level heating

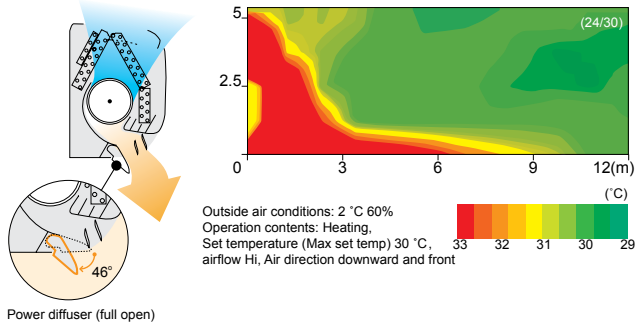

“Horizontal airflow” does not blow cool air directly at the occupants in the room

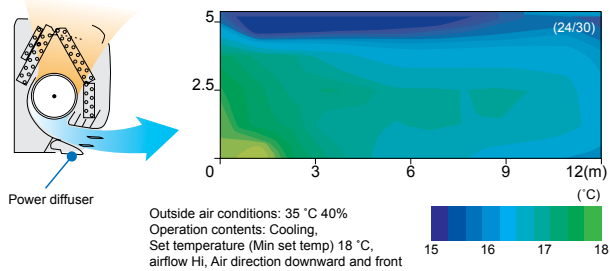

Easy maintenance

Simplification of drain pan cleaning improves maintenance-ability.

Air conditioner filter features

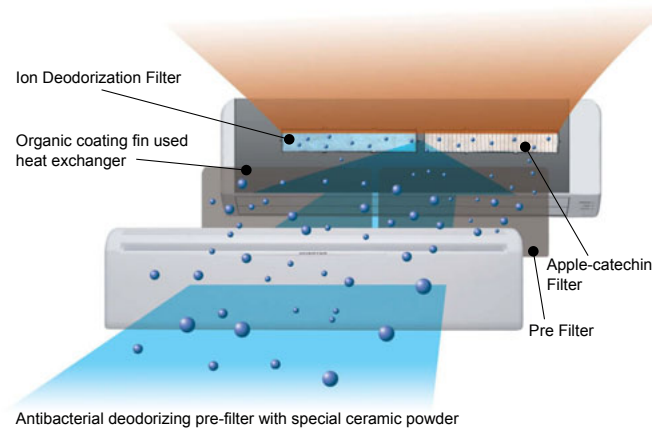

Long-life* Ion Deodorization Filter

The filter deodorizes by powerfully decomposing absorbed odors using the oxidizing and reducing effects of ions generated by the ultra-fine-particle ceramic.

(*The filter can be used for approx. 3 years if it is washed under water to restore its surface action when it is dirty.)

✦ Using different filters at both sides

Apple-catechin Filter

Fine dust, invisible mold spores, and harmful microorganisms are absorbed onto the filter by static electricity, and further growth is inhibited and deactivated by the polyphenol extracted from apples.

Dimensions (Unit : mm)

Models: AS*A18 / AS*A24 / AS*A30

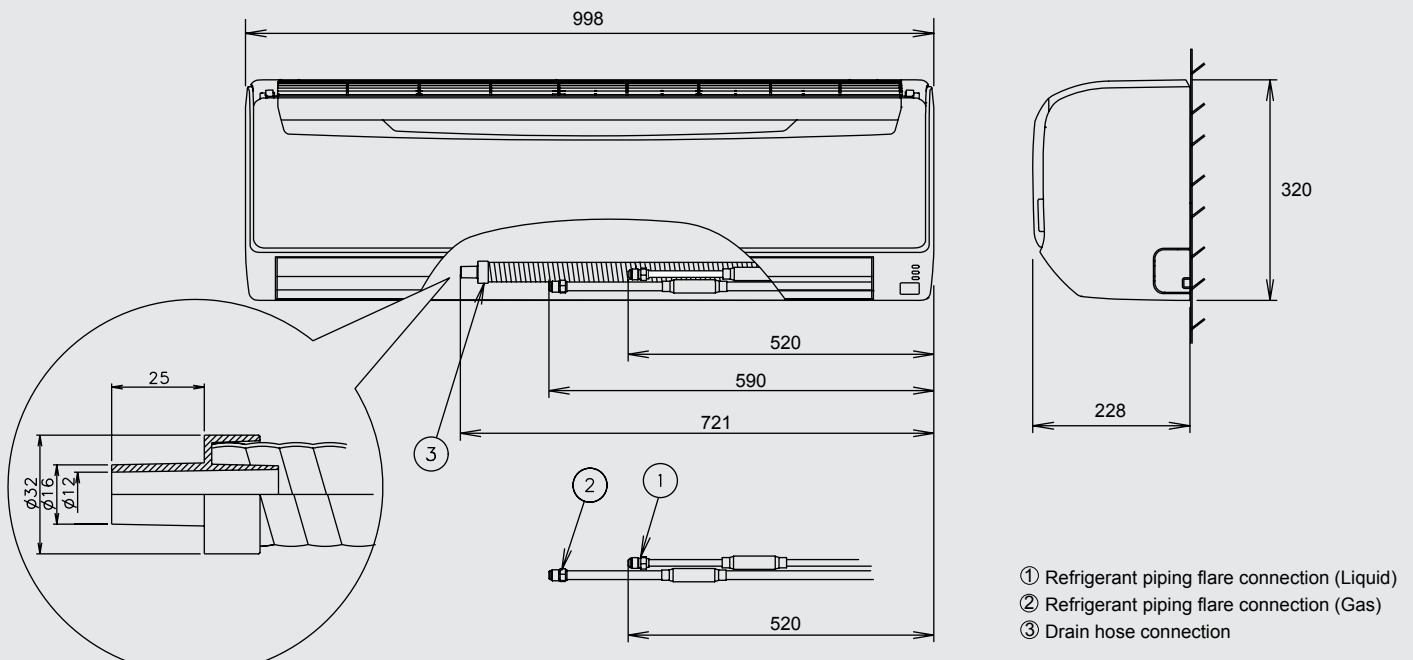

Control System

Every user's needs are supported by offering a variety of controls, such as individual control, central control and building management control options.

Building Management

General-purpose Building Control Computer

Connectable to various sized BMS/BAS *1

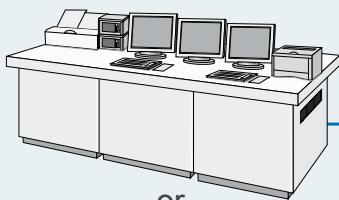

OR



Air Conditioning Central Control

System Controller Software

UTY-APGX
UTY-PEGX(Optional)

Internet or Public Telephone Line

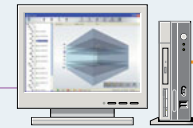

USB Adaptor*2
(Field supplied)



Remote / Monitoring side

Touch Panel Controller

UTY-DTG*



G*:GY(FUJITSU), GG(GENERAL)

Central Remote Controller

UTY-DCG*



G*:GY(FUJITSU), GG(GENERAL)

Group Remote Controller

UTY-CGG*



Network Converter
UTY-VGGXZ1

G*:GY(FUJITSU), GG(GENERAL)

BACnet® Gateway Software

UTY-ABGX



USB Adaptor*2
(Field supplied)

Network Converter (BMS / LONWORKS®)

UTY-VLGX

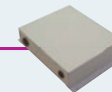

Web Monitoring Tool Software

UTY-AMGX



Internet or Public Telephone Line



USB Adaptor*2
(Field supplied)

(Monitoring side)

(VRF system side)

*1. BMS/BAS: Building Management System / Building Automation System

*2. USB Adaptor is U10 USB Network Interface of Echelon® Corporation.

The devices above cannot be connected to the S series. (Except System Controller & BACnet® Gateway)

Air Conditioning Individual Control

Wired Remote Controller (Touch panel)

UTY-RNR*

R*: RY(FUJITSU), RG(GENERAL)



Wired Remote Controller

UTY-RNK*

K*: KY(FUJITSU), KG(GENERAL)



Simple Remote Controller

UTY-RSK*

K*: KY(FUJITSU), KG(GENERAL)



Simple Remote Controller

UTY-RHK*

Without operation mode

K*: KY(FUJITSU), KG(GENERAL)



Wireless Remote Controller

UTY-LNH*

H*: HY(FUJITSU), HG(GENERAL)



Card-key

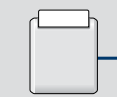

(Field supplied)

External Switch Controller

UTY-TEKX



Service Tool

Software

UTY-ASGX



USB Adaptor *2



(Field supplied)

System

Outdoor unit

Indoor unit

Outdoor unit

Indoor unit

Signal Amplifier

UTY-VSGXZ1

IR Receiver Unit

UTB-YWC

IR Receiver Unit

UTY-LRH*B1

*B: YB(FUJITSU), GB(GENERAL)

For single split

Network Converter

UTY-VGGXZ1

— Transmission line (VRF Network)

— Module link

— Remote controller line (2 wires)

— Remote controller line (3 wires)

— USB cable

— LONWORKS® Network

— Ethernet

— Signal line(Single split system)

— Group Remote Controller line







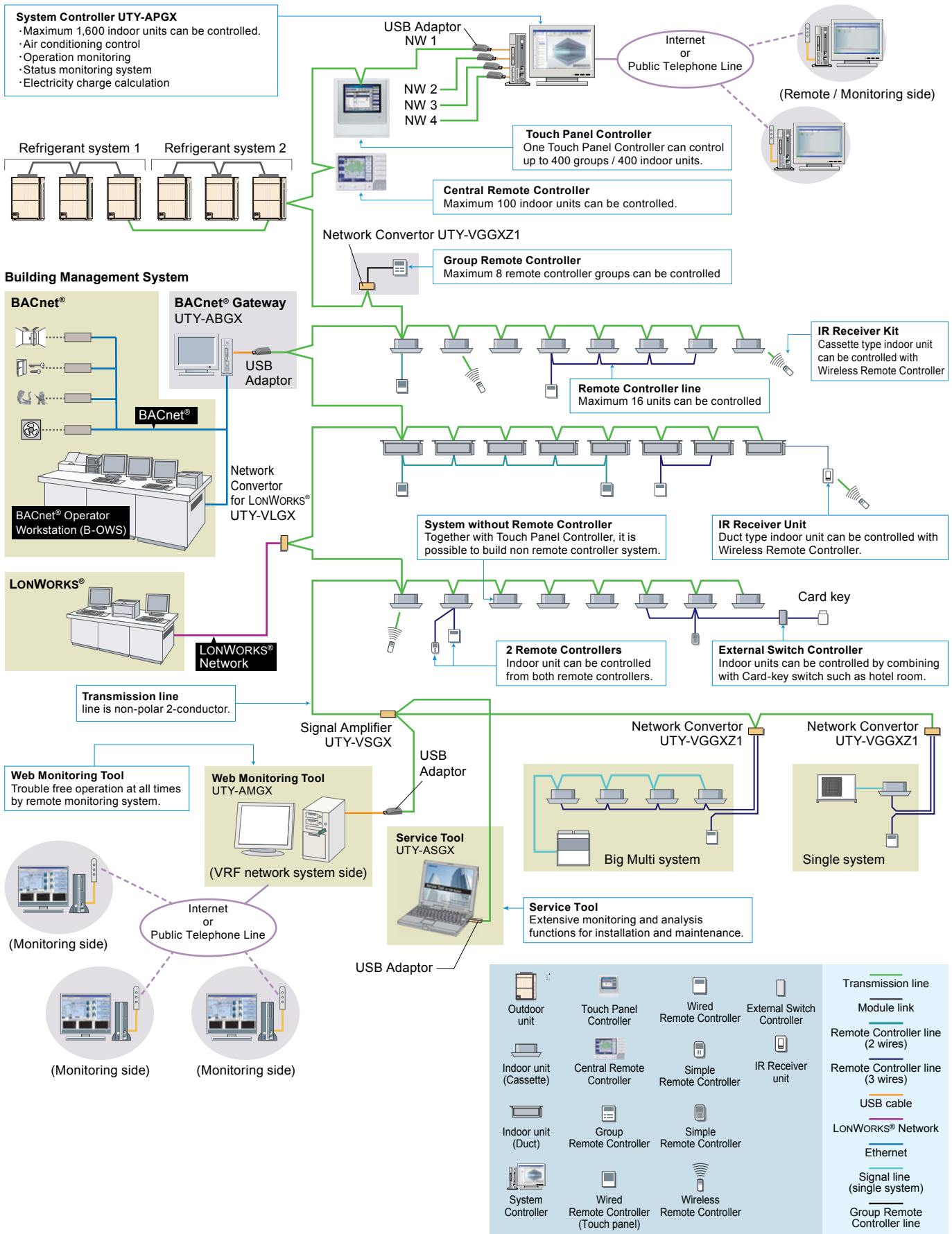

Wiring system

Max. transmission line length
3,600m

- Wiring construction of the control system is made of power source wiring, transmission wiring and remote controller wiring.
- Total wiring length (total length of transmission line) can be extended up to 3,600m (by using signal amplifiers).



Comparison table of Controllers

Item												
Model name	UTY-RNRY UTY-RNRG	UTY-RNKY UTY-RNKG	UTY-RSKY UTY-RSKG	UTY-RHKY UTY-RHKG	UTY-LNHY UTY-LNHG	UTY-CGGY UTY-CGGG	UTY-DCGY UTY-DCGG	UTY-DTGY UTY-DTGG	UTY-APGX			
Max. controllable remote controller groups	1	1	1	1	1	8	100	400	1600			
Max. controllable indoor units	16	16	16	16	16	96	100	400	1600			
Max. controllable groups	-	-	-	-	-	-	16	400	1600			
Air conditioning control function	On / Off	●	●	●	●	●	●	●	●			
	Operation mode setting	●	●	●	-	●	●	●	●			
	Fan speed setting	●	●	●	●	●	●	●	●			
	Room temp. setting	●	●	●	●	●	●	●	●			
	Room temp. set point limitation	●	-	-	-	-	●	●	●			
	Test operation	●	●	●	-	●	-	●	●			
	Up/down air direction flap setting	●	●	-	-	●	-	●	●			
	Right/left air direction flap setting	●	●	-	-	●	-	●	●			
	Group setting	-	-	-	-	-	-	●	●			
	RC prohibition	-	-	-	-	-	-	●	●			
	Anti freeze setting	●	-	-	-	-	-	●	●			
	Setback cool/heat	○	-	-	-	-	-	-	-			
	Economy mode setting	●	●	-	-	●	-	●	●			
	Display	Failure	●	●	●	●	-	●	●	●		
Defrosting		●	●	●	●	-	-	●	●			
Current time		●	●	-	-	●	●	●	●			
Day of week		●	●	-	-	-	●	-	●			
R.C. prohibition		●	●	●	●	-	●	●	●			
Cooling/heating priority		●	●	●	●	-	●	●	●			
Address display		●	●	●	●	-	●	●	●			
Room temp		●	-	-	-	-	-	-	-			
Multi language		●	-	-	-	-	-	●	●			
Summer time		●	-	-	-	-	-	●	●			
Name registration		●	-	-	-	-	-	●	●			
Backlight		●	-	●	●	-	-	●	●			
Timer		Schedule timer	Period	Week	Week	-	-	-	Week	Week	Year	Year
			On/Off, Temp, mode, times per day	8	4	-	-	-	4	20	20	144
	On/off timer	●	●	-	-	●	-	-	-	-		
	Sleep timer	-	-	-	-	●	-	-	-	-		
	Program timer	-	-	-	-	●	-	-	-	-		
	Auto off timer	●	-	-	-	-	-	-	-	-		
	Day off	●	●	-	-	-	-	●	●	●		
Min. unit of timer setting (Minutes)	10・30	30	-	-	5	10	10	10	10			
Control	Status monitoring system	-	-	-	-	-	-	●	●	●		
	Electricity charge calculation	-	-	-	-	-	-	-	-	●		
	Error history	●	●	●	●	-	●	●	●	●		
	Emergency stop	-	-	-	-	-	-	● ^{*2}	● ^{*2}	-		
	Control via internet	-	-	-	-	-	-	-	-	●		
	E-mail notification for malfunction	-	-	-	-	-	-	-	-	●		
Key lock	● Child lock	-	-	-	-	● Child lock	● Password setting	● Password setting	● Password setting			

*1 "Operation mode" setting is not available for this model.
 *2 This function is available only through external input. control.

● : Supported ○ : Supported soon
 — : Not supported yet

Wired Remote Controller (Touch Panel)

UTY-RNR*

Max. controllable
16
indoor units

Easy operation by high-definition large STN-LCD touch panel screen

- Easy finger touch operation with LCD panel
- Built-in weekly/Daily timer(ON/OFF,Temp.,Mode)
- Backlight enables easy operation in a darkened room
- Room temperature display
- Control up to 16 indoor units
- Corresponds to 7 different languages (English, Chinese, French, German, Spanish, Russian, Polish)

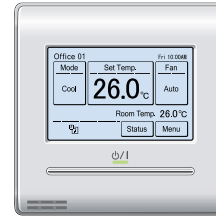

Functions

High performance and compact size

- In addition to the individual control, various energy saving controls can be realized using one remote controller only.



Accurate and comfortable control

- Indoor temperature can be detected accurately by the inclusion of a thermo sensor in the body of the wired controller.

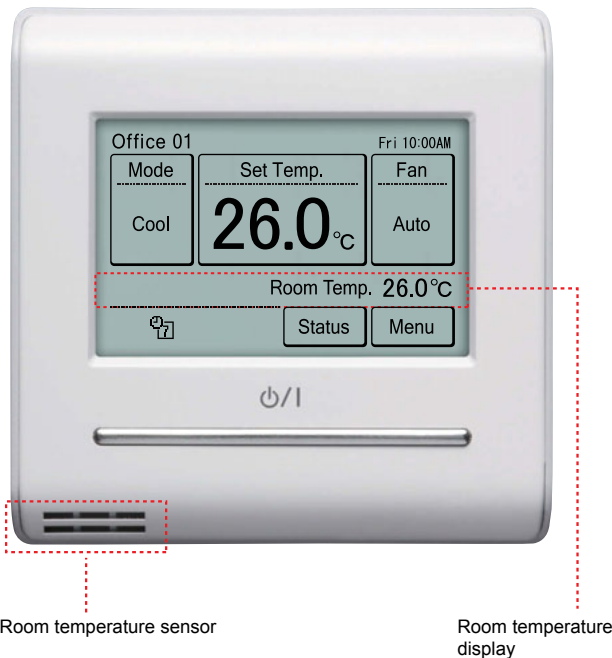

Room temperature sensor

Room temperature display

Various energy saving control

Auto OFF Timer

- The indoor unit automatically turns off after a set time has passed.
- The time interval for which auto off works can be set.

Ex) At interval time hour (17:00 to 24:00) to prevent forgetting to turn off

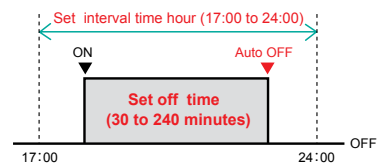

2 schedules Weekly Timer

- 2 schedules such as for the summer and winter can be set.
- 8 setting changeable per day of week (Setting items: On/Off, Temperature, Mode, Time)

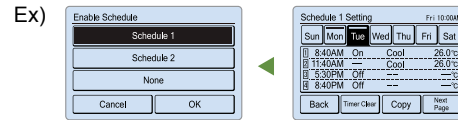

Schedule 1 (Summer schedule)

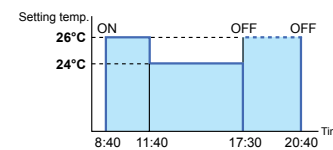

Schedule 2 (Winter schedule)

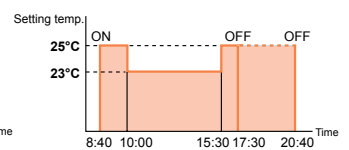

Set Temperature Auto Return

- The setting temperature automatically returns to the previous setting temperature.
- The time range in which the set temperature can be changed is 10 to 120 minutes.

Cooling operation

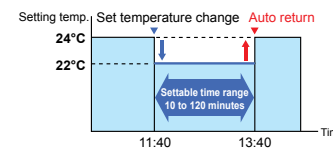

Heating operation

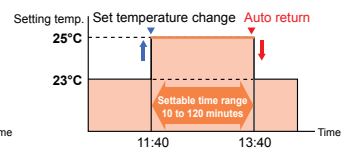

Set Temperature Upper and Lower Limit Setting

- The set temperature range can be set for each operation mode. (Cooling / Heating / Auto)

During Cooling

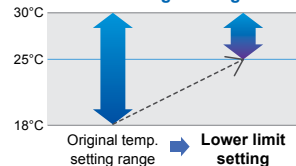

During Heating

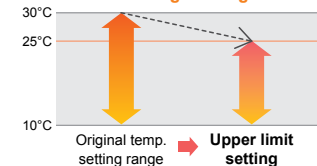

Backlight

- Backlight enable easy operation in a darkened room.
- For the lighting time of Backlight, 30 or 60 seconds can be set.
- Backlight activates while the buttons are operated and goes off 30 or 60 seconds after the operation stops.

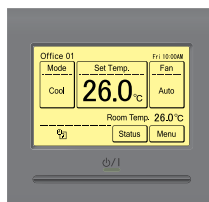

Various convenient functions

Setback-Cool / Setback-Heat (Future release)

• Cooling / Heating is automatically started when the room temperature reaches a setting temperature even if the indoor unit is off.

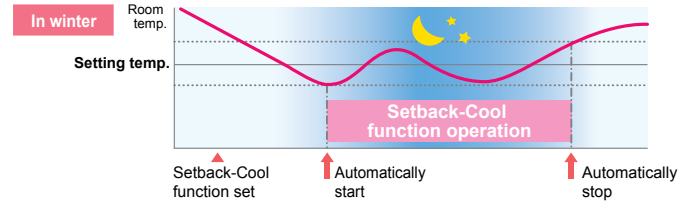
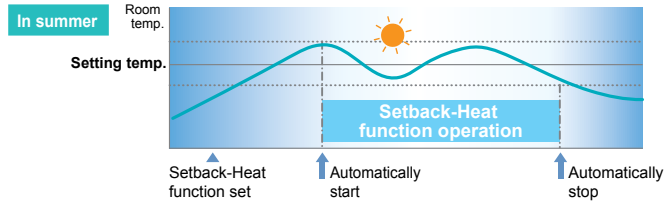

Displays setting status and Limitations

• The remote controller settings can be easily checked

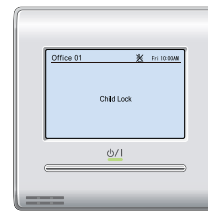
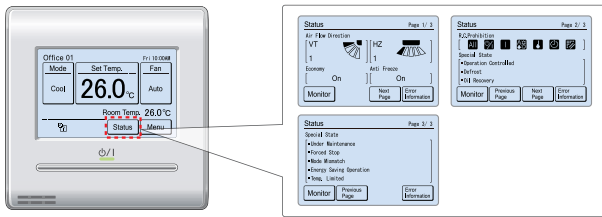

Child lock

• Lock / unlock method: Push the ON/OFF button and the screen (4 seconds)

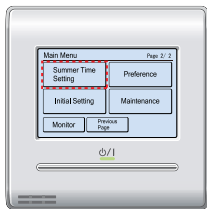

Summer Time display

• This function can be set easily from Menu screen

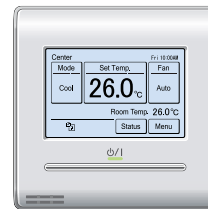

Name Registration

• Indoor unit names can be registered in the remote controller screen. This makes it easy to identify the indoor unit you want to control in the room.

Simplified installation

Uses non-polar 2-wire type

• The faulty wiring can be prevented by using non-polar 2-wire.

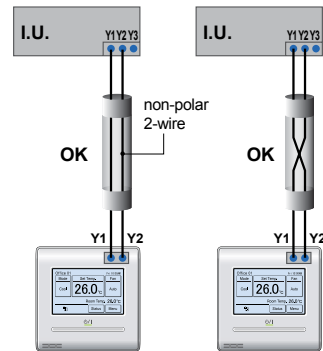

Auto Address Setting/Setting Position Notification

• Reduce errors and install time compared with the current specification Rotary SW

• When will be set remote controller groups, can also be set automatically new Wired remote controller address

• After auto address setting of new wired remote controller groups, what number can also confirm addresses

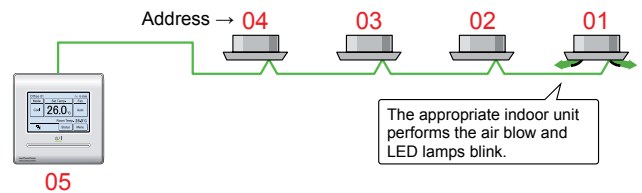

Easy Maintenance

Error History Display

• The errors that occur in the indoor unit or remote controller are saved as a history.

• A maximum of 32 error incidents can be saved.

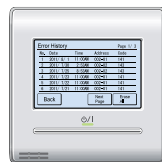

Specifications

Model name	UTY-RNR*
Power Supply	DC 12V
Dimensions (H x W x D) (mm)	120 x 120 x 20.4
Weight (g)	220

DC12V is supplied by the indoor unit. R* : RY(FUJITSU), RG(GENERAL)

Wired Remote Controller

UTY-RNK*

Max. controllable
16
indoor units

The room temperature can be controlled by detecting the temperature accurately from the built-in sensor

- Simple operation with Built-in Weekly / Daily Timer.
- Control up to 16 indoor units.
- Up to 2 wired remote controllers can be connected to a single indoor unit.

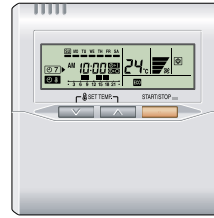

Functions

Powerful features and compact size

This Wired Remote Controller incorporates four primary functions into a single unit.



Accurate and comfortable

Indoor temperature can be detected accurately by the inclusion of a thermo sensor in the body of the wired controller. This new wired remote controller and the optional remote sensor allows flexibility in sensor location, suitable for all requirements.

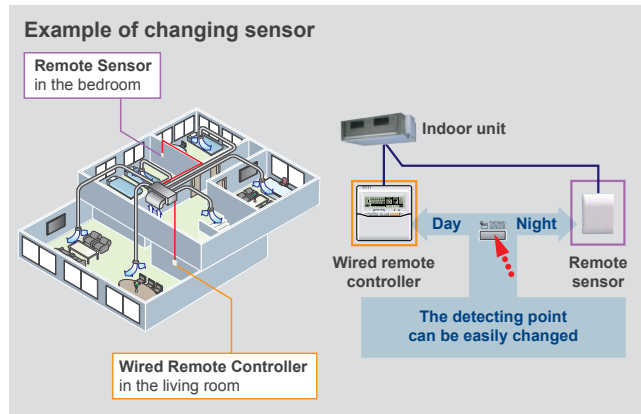
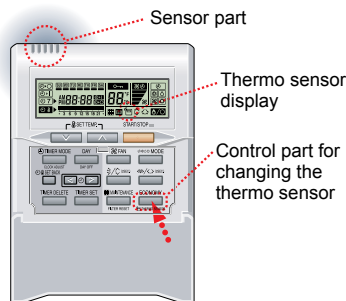

Displayed temperature is set temperature.

Built-in timers

Easy-to-understand time bar display

Weekly timer : Possible to set ON/OFF time to operate twice each day of the week.

Setup screen example
Set to Wednesday: 8:00 to 20:00.

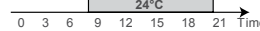

Screen after setup



Setback timer: Possible to set temperature for two times spans and for each day of the week.

Setup screen example
Set from Sunday to Saturday: 12:00 to 15:00, 28°C.



At "Weekly timer" + "Set back timer" setup

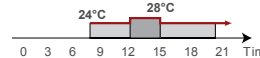

24°C → 28°C → 24°C

Diagnosis check function

Two methods are available for determining the cause of failure in the event of a malfunction occurs:

- Malfunction diagnosis function
- Error history (Last 16 error codes can be accessed)

Simple installation

Components are compatible with standard switch boxes. Flat back surface allows to be installed wherever it is needed.

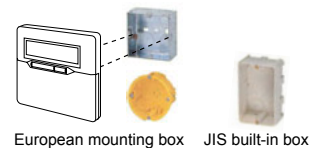

Specifications

Model name	UTY-RNK*
Power Supply	DC 12V
Dimensions (H x W x D) (mm)	120 x 120 x 18
Weight (g)	160

DC12V is supplied by the indoor unit. K* : KY(FUJITSU), KG(GENERAL)

Simple Remote Controller

Max. controllable
16
indoor units

UTY-RSK*

UTY-RHK* (Without Operation mode)

Compact remote controller provides access to basic functions

- Up to 16 indoor units can be controlled with one remote controller.
- Suitable for hotels or offices as it is easily operated with no complex functions.



UTY-RSK*



UTY-RHK*
Without Operation mode

Functions

User-friendly operation

- Provides access to basic operations, such as Start / Stop, Fan control, Operation mode switching, and Room temperature setting.
- A large On / Off button is provided in the centre of the remote controller for easy operation.
- Can be used jointly with other individual control unit.
- Following an error display, diagnostics can be carried out on the controller.

Backlight

- Backlight enables easy operation in a darkened room.
- Backlight activates during all button operations, and lasts 10 seconds in Operation mode and 5 seconds in stop mode after a button is pressed.



Simple installation

Can be mounted on the European Mounting Box (Installation dimension: 60mm) or the JIS Built-in Box (Installation dimension: 83.5mm).



Functions summary

Model	UTY-RSK*	UTY-RHK*
Operation	●	●
On / Off	●	●
Fan control	●	●
Operation mode	●	— *1
Room temp. setting	●	●

*1: "Operation mode" setting is not available.
It is recommend to use together with other type controller.

Specifications

Model name	UTY-RSK*	UTY-RHK*
Power Supply	DC 12V	
Dimensions (H x W x D) (mm)	120 x 75 x 14	
Weight (g)	90	

DC12V is supplied by the indoor unit. K* : KY(FUJITSU), KG(GENERAL)

Wireless Remote Controller

UTY-LNH*

Simple and sophisticated operations with a choice of 4 daily timers

• A single controller controls up to 16 indoor units.



Max. controllable
16
indoor units

Selectable
4
daily timers

Functions

Built-in daily timer

Select from 4 different timer programs :

On / Off / Program / Sleep

Program timer : The program timer operates the ON and OFF timer once within a 24 hour period.

Sleep timer : The sleep timer function automatically corrects the set temperature according to the time setting to prevent excessive cooling or heating during sleep hours.

Cooling operation/dry operation

When the sleep timer is set, the set temperature automatically rises 1°C every hour. The set temperature can rise up to a maximum of 2°C.

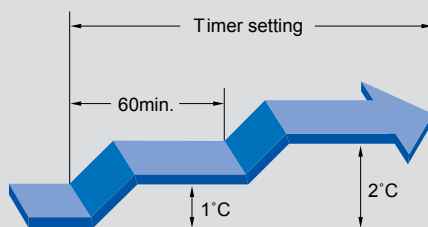

Heating operation

When the sleep timer is set, the set temperature automatically drops 1°C every 30 minutes. The set temperature can drop to a max. of 4°C.

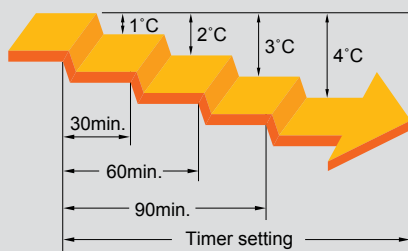

Easy installation and operation

Code selector switch prevents indoor unit mix-up. (Up to 4 codes can be set.)

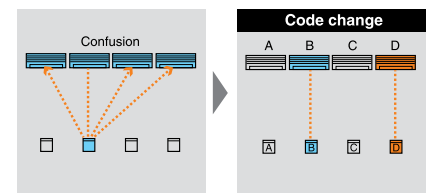

Wide and precise

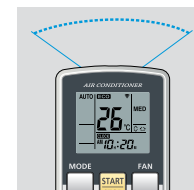

Address setting

During installation work, address setting can be performed using the Wireless Remote Controller, thus eliminating manual switch setting.

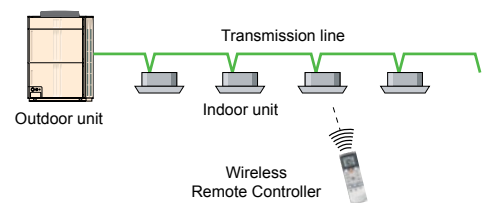

Specifications

Model name	UTY-LNH*
Battery	1.5V (R03 / LR03 / AAA) x 2
Dimensions (H x W x D) (mm)	170 x 56 x 19
Weight (g)	85

H* : HY(FUJITSU), HG(GENERAL)

IR Receiver Unit

UTB-YWC

Necessary to control for all duct type by Wireless Remote Controller



Wiring connection

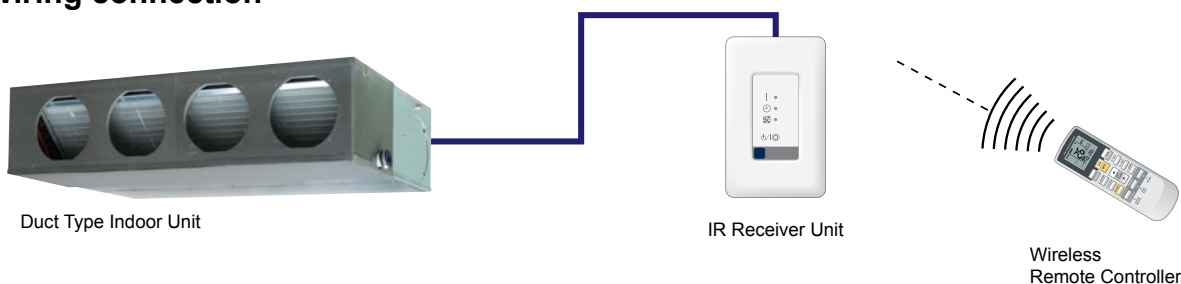

Specifications

Model name	UTB-YWC
Battery	DC 12V
Dimensions (H x W x D) (mm)	145 x 90 x 30
Weight (g)	150

IR Receiver Unit

UTY-LRH*B1

Cassette type indoor unit can be controlled with Wireless Remote Controller



Specifications

Model name	UTY-LRH*B1
Battery	DC 12V
Dimensions (H x W x D) (mm)	193.9 x 193.9 x 31.2
Weight (g)	140

H* : YB(FUJITSU), GB(GENERAL)

Group Remote Controller

UTY-CGG*

Max. controllable
8
remote controller
groups

Max. connectable
64
group R.C. in
a VRF network
system

Group control of indoor units with simple operation

- Up to 8 remote controller groups can be controlled by one Group Remote Controller.
- Up to 64 Group Remote Controllers can be connected in one VRF network system.
- Network Converter (UTY-VGGXZ1) is required to connect Group Remote Controllers to a VRF network system.
(Network Converter allows up to 4 Group Remote Controllers)

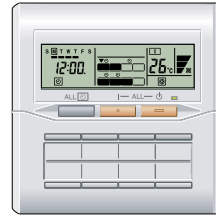

Functions

High performance and compact size

ON / OFF, Operating mode, Room temperature and Fan speed setting can be controlled / monitored centrally or individually.



Control up to 8 remote controller groups

Single Group Remote Controller controls and monitors up to 8 remote controller groups.

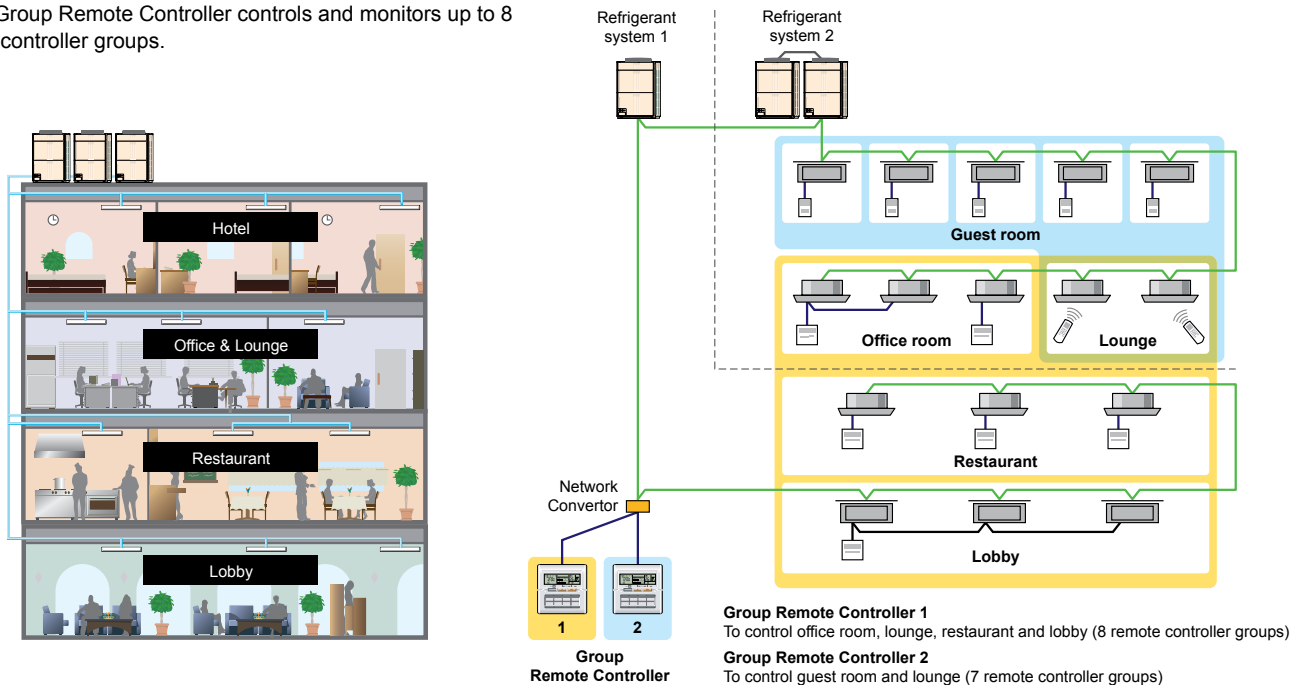

Built-in weekly timers

The weekly timer is provided as a standard function.

1. The timer can be set up for up to 4 times per day. (On / Off, operating mode, set temperature)
2. Allows separate settings for each day of the week.

ON / OFF switching

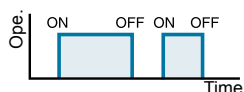

Air conditioning ON/OFF setting corresponding to air conditioning specification needs is possible.

Cooling / Heating switching

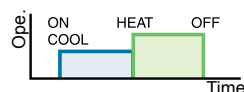

Switching between the cooling mode and heating mode can be set by time.

Temperature switching (Peak power cut)

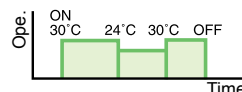

Since peak power cut is performed in a planned way, setting which changes the room temperature linked with time is possible.

Temperature switching (Anti-freeze)

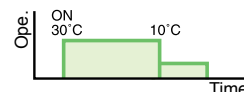

Low temperature heating operation can be set to prevent freezing in cold regions at night, etc.

Stop setting

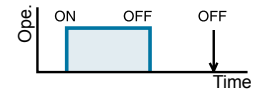

Indoor unit stop setting at operation end time is possible.

Useful functions

1 Timer setting at all the connected indoor units is possible by centralized timer on the front panel.

2 All the connected indoor units can be turned on / off simultaneously by centralized ON/OFF button on the front of the cover.

3 The indoor unit can be quickly turned on and off by ON / OFF button of each indoor unit on the front of the door.

Indoor Unit Name Labels
Write the names of the indoor units on the included labels and attach them.

ON / OFF Button
Press the ON / OFF button to turn the corresponding indoor unit on or off.

ALL TIMER Button
Press the ALL TIMER button to turn the timer operation on or off for all indoor units.

Indoor Unit Operation Indicators
Timer setting at all the connected indoor units is possible by centralized timer on the front panel.
■ : On □ : Off
○ : Timer operation ▼ : Selection

Operation Lamp
This is on if any of the indoor units is operating. This flashes if any of the indoor units has malfunction(s).

ALL OFF Button
Press the ALL OFF button to turn off all of the indoor units.

ALL ON Button
Press the ALL ON button to turn on all of the indoor units.

With cover closed

Timer and Clock Display and setting

Setting Display
Day Display
Timer and Clock Display
Timer Mode Display
Timer Mode (DELETE) Button
DAY Button
Set Time Button
PROGRAM (CLOCK ADJUST) Button
ENTER Button

With cover open

Displaying the Status and Controlling indoor units

Transmission Display
Operation Lock Display
ON / OFF Display
Fan Speed Display
Set Temperature Display
Operation Mode Display
ON / OFF Button
Select Button
Fan Control Button
Master Control Button*1, *2, *3
Set Temperature Button
Child Lock Function

- *1 : "AUTO" (Ⓐ) is not available for a heat pump model unless it is set up for the master indoor unit.
- *2 : "FAN" (⌘) is not available for a heat pump model
- *3 : "HEAT" (⊙) is not available for a cooling only model

Specifications

Model name	UTY-CGG*
Power Supply	DC 12V
Dimensions (H x W x D) (mm)	120 x 120 x 18
Weight (g)	200

DC12V is supplied by a network converter. G* : GY(FUJITSU), GG(GENERAL)

Central Remote Controller

UTY-DCG*

Central control of small- and medium-sized buildings and tenants. The operation status of all connected indoor units can be viewed at a glance on a large LCD monitor to simplify individual control to batched control.

Max. controllable
100
Indoor units

Max. controllable
16
groups



- Individual control and monitor of 100 indoor units
- 5 inch TFT color screen
- User friendly view and easy operation
- External input / output contact
- Detachable power supply unit
- Corresponds to 7 different languages (English, Chinese, French, German, Spanish, Russian, Polish)

User friendly operation

Operation status monitor displays for all indoor units
Easy comprehensible display and operation button

Function Menu

Function menu displays the items to select.

Registration indoor unit

Operation guidance



Function button
1 to 1 function button supports easy setting.

System overview

- It allows multiple indoor units grouping (Max.16 groups controlled)
- Interlock with external device

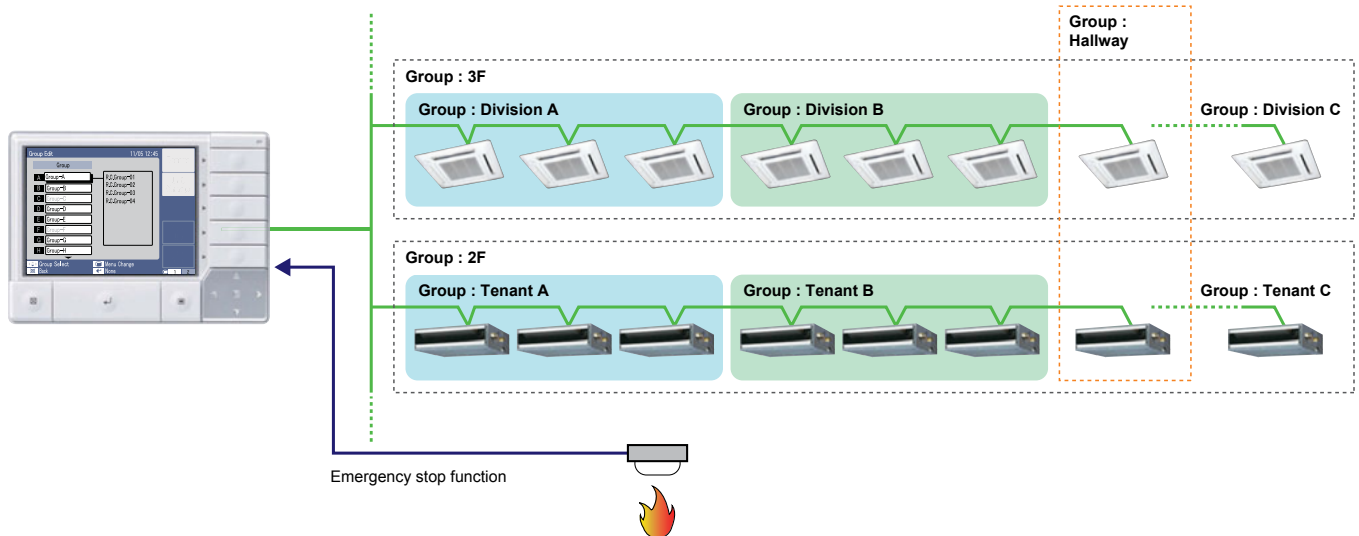

Functions

Diverse control of indoor units

- Individual control (On / Off, Mode, set Temp, Fan speed, Economy operation, Antifreeze operation)

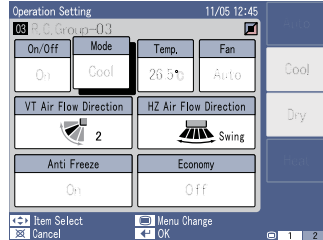

- Remote controller prohibition (All, On / Off, Mode, Temp, Timer, Filter) :** R.C prohibition setting prohibits individual remote control operation from this controller

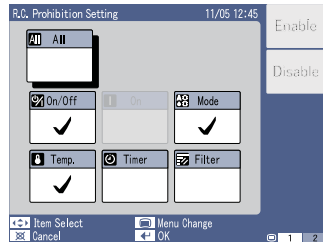

- Room temperature set point upper and lower limitation

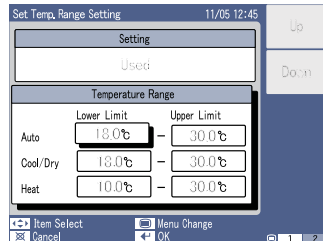

- Weekly timer :** Weekly timer can set the timer by various combinations.

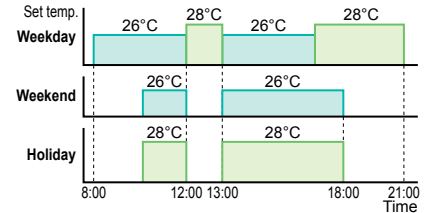

- Automatic clock adjustment :** The time setting of each controller can be set in batch automatically.

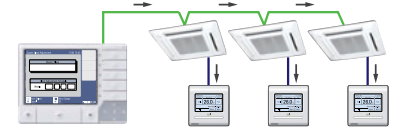

Error history

- Max 200 Errors memorize.
- Suitable maintenance is possible by analysis of the error history data.

No.	Date Time	Name	Address	Error Code
001	2009/09/01 13:05	R.C.Group-01	01-00-00	14
002	2009/09/01 13:05	R.C.Group-01	01-00-00	14
003	2009/09/01 13:05	R.C.Group-01	01-00-00	14
004	2009/09/01 13:05	R.C.Group-01	01-00-00	14

Easy Installation

- The control panel and power supply unit can be installed separately.
- For flexibility in installation, the Control panel can be built into the wall or fix on the wall.

Setting pattern 1

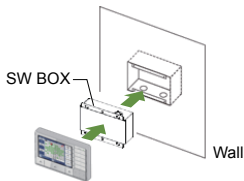

Control panel + Power supply unit

Setting pattern 2

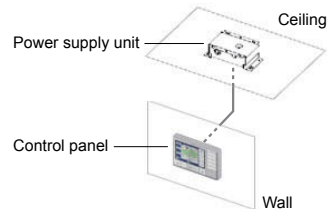

- Automatic or manual indoor unit registration

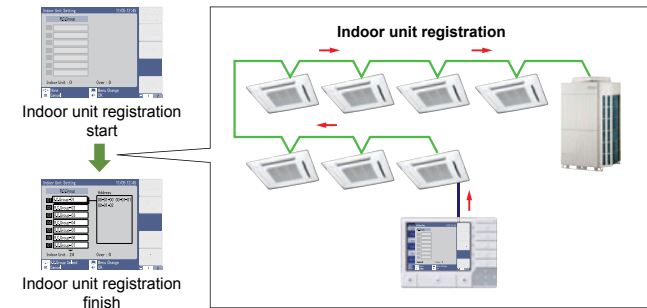

Specifications

Model name	UTY-DCG*	
	Control Panel	Power Supply Unit
Power Supply	DC 5 V	100-240V, 50-60Hz, Single phase
Dimensions (H x W x D) (mm)	120 x 162 x 25.7	99 x 135 x 39.2
Weight (g)	308	355

<PACKING LIST>

Packing List	Control Panel / Power Supply Unit / Connecting cable, etc.
--------------	--

G* : GY(FUJITSU), GG(GENERAL)

Touch Panel Controller

UTY-DTG*

Max. controllable
400
Indoor units

High visibility and easy operation via high resolution 7.5 inch TFT-LCD touch panel screen



- Large-sized 7.5-inch TFT color
- LCD Easy finger touch operation
- Stylish shape and design to suit all application
- No additional component is required for installation
- Up to 400 indoor units can be controlled
- Selectable 2 display types (Icon / List) in monitoring mode
- Corresponds to 7 different languages, English, Chinese, French, German, Spanish, Russian, Polish.

Functions

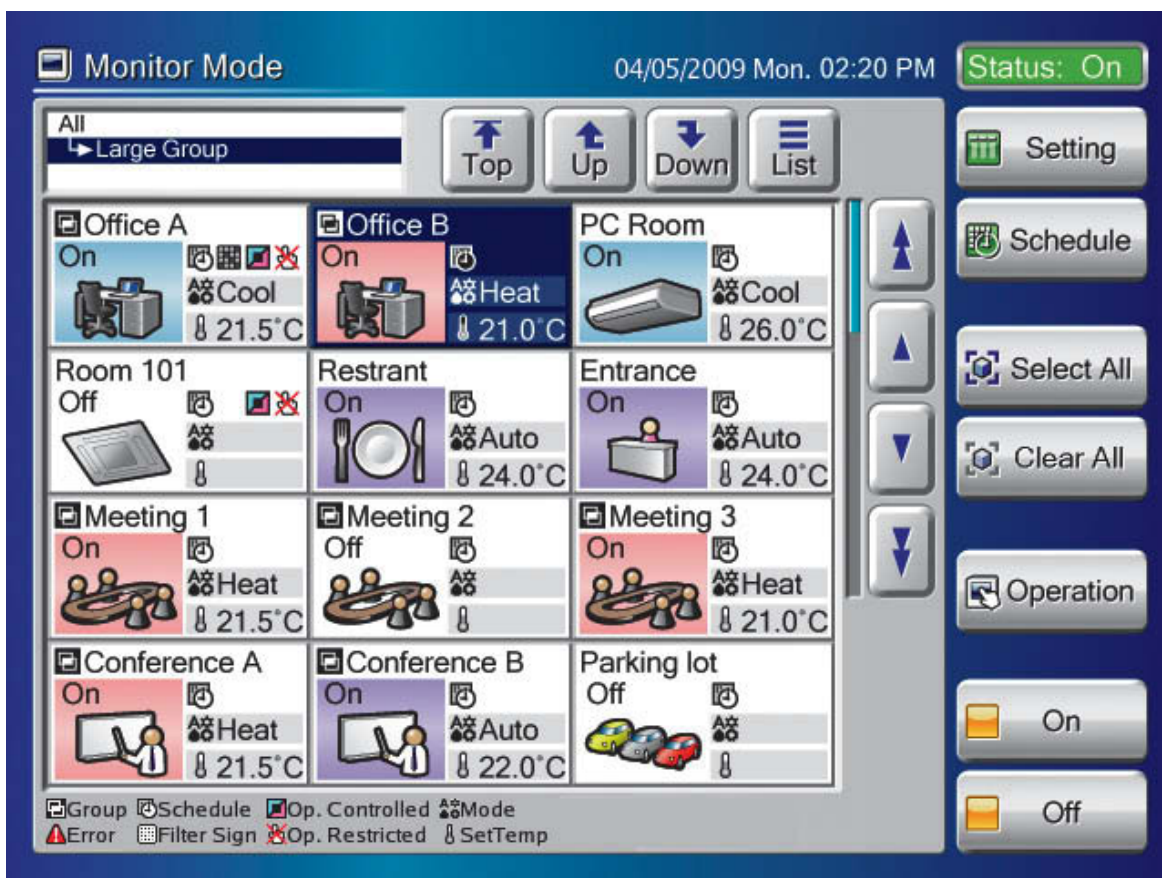

Real size screen image

Easy operation

- Large and wide-angled LCD is easily viewable even at a distance
- Easy-to-understand icon-driven Graphical User Interface (GUI)
- Wide range of simple-to-understand icons



- Operation can be selected using your finger or the dedicated touch pen by pressing the appropriate on-screen icon
- Up-to-date status display
- Background color identifies current control operation Blue for monitoring, green for operational control

Easy maintenance

- Flat touch screen is easily cleaned
- Non-glare coating on touch panel controller minimizes fingerprint marking
- Easy-to-remove front cover



Up to 400 indoor units can be controlled

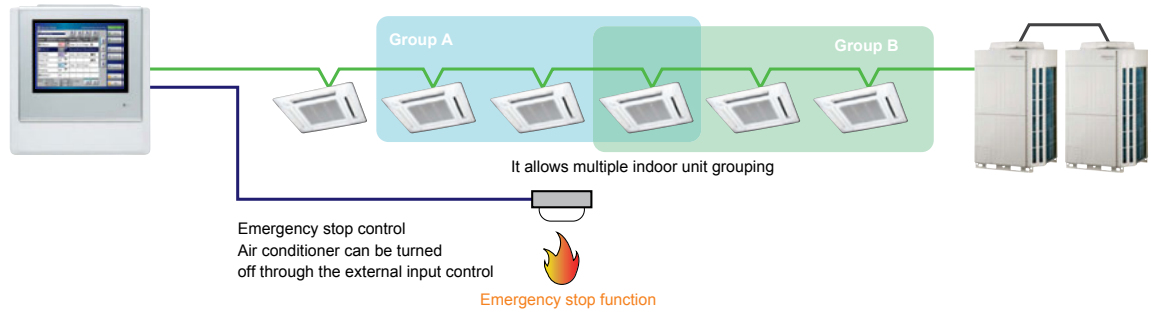

Function

- Up to 400 indoor units can be controlled
- It allows multiple indoor units grouping
- Schedule timer function is standard (20 patterns per day)
- Emergency stop function(through the external input control)
- Temperature upper and lower limit setting
- The clock of each indoor unit correct setting



Individual control



Flexible grouping



Schedule control



Indoor units operation monitoring

Automatic clock adjustment

The time setting of each controller can be set in batch automatically.

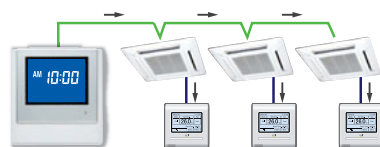

Versatility

CSV format data edited by PC can be imported to Touch Panel Controller.

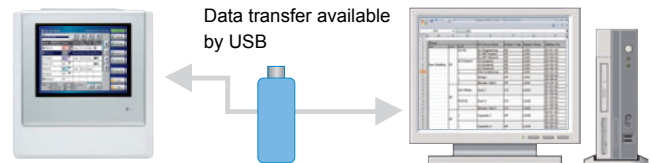

Easy installation

Touch Panel Controller is easily mounted to the wall Flat back surface allows to be installed wherever it is needed.

- Correctable mechanism for tilting (horizontal) after the installation of the body

No additional component is required for installation

- There is no need for the installation space of power supply adaptor and transmission adaptor etc.

Specifications

Model name	UTY-DTG*
Power Supply	100-240V 50/60Hz, Single phase
Dimensions (H x W x D) (mm)	260 x 246 x 54
Weight (g)	2,150
Interface	USB 2.0

G* : GY(FUJITSU), GG(GENERAL)

System Controller

Software

UTY-APGX

System Controller realizes the advanced integrated monitoring & control of VRF network system from small scale buildings to large scale buildings.

- Up to a maximum of 4 VRF network systems, 1600 indoor units, and 400 outdoor units can be controlled.
- Supports VRF S series, V series and V-II series.
- In addition to air conditioning precision control function, central remote control, electricity charge calculation, schedule management, and energy saving functions are strengthened and building manager and owner needs are met.

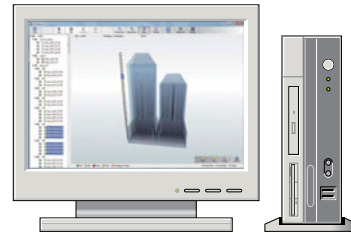

Max. controllable
4
VRF network systems

Max. controllable
400
Outdoor units

Max. controllable
1,600
Indoor units

Functions

User friendly view and operation

- **Click & Operate** : The property is shown visually from the perspective most suitable for operation and operated accordingly (Click & Operate). You can select from among the 4 displays of site, building, floor, or list.
- **Freely define groups for batched control** : Indoor units can be freely grouped for simple batched control from a tree menu. Grouping by hierarchal structure, such as by section, division or department is possible.

Click & Operate the whole building !

Properties can be shown using one of the four displays of site, building, floor, or list.

Click & Operate any specified unit(s)!

The display is easily changed by pressing the button.

Site view

Building view

Batched control of freely defined groups

Batched control of freely selected units

Click & Operate the whole floor !

The floor layout drawing can be imported to easily make the settings for the actual building.

Floor view

Click & Operate the unit !

List view

Energy saving management

With UTY-PEGX Option

Peak cut operation Option

A power meter is connected to detect the total power consumption while shifting the indoor unit set temperature, set the indoor unit forced thermostat off, and taking other measures to carefully control the power consumed while maintaining comfort and conducting control to maintain the target power consumption set for each time. The indoor units to be controlled can be freely grouped and the control level can be set.

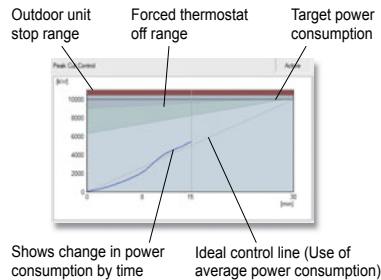

Outdoor unit capacity save Option

Outdoor unit capacity save switches the outdoor unit capability upper limit to suppress power consumption during hot summers and cold winters by averaging the power saving effect of each refrigerant system. You can select from 50% or more of the capacity upper limit.

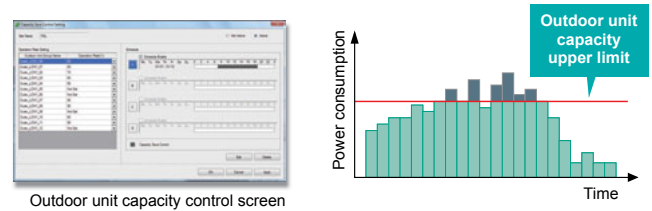

Indoor unit rotation operation Option

The operation of indoor units can be automatically rotated within a group in accordance with the set annual schedule to reduce power consumption while maintaining comfort. The indoor unit operation stoppage rate can be selected.

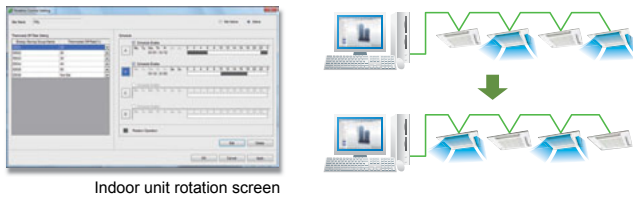

Batched stop

Batched stop at a freely set time for a property, building, or freely set block unit can be done to prevent any air conditioning unit from being forgotten to be turned off at the end of office hours, etc. In addition, any air conditioning unit whose operation is left on can be immediately identified by the icon color for a building or indoor unit in the monitoring screen and batched stop conducted in response.



Electricity charge apportionment

Electricity charge apportionment calculation framework

Suppose you want to find the power consumed by the air conditioners of each tenant from the electricity charge for each month. With electricity charge apportionment function, used energy apportionment ratio will be provided, calculating in detail the energy consumed by the units used by each tenant. This information is then used to calculate the charges for the electricity consumed for air conditioning by each tenant from the total electricity charges in the bill from the electric power company. (See figure at right) The detailed calculation takes into consideration such things as unused rooms and nighttime electricity charges and shows them in a charges calculation sheet.

System Configuration Example

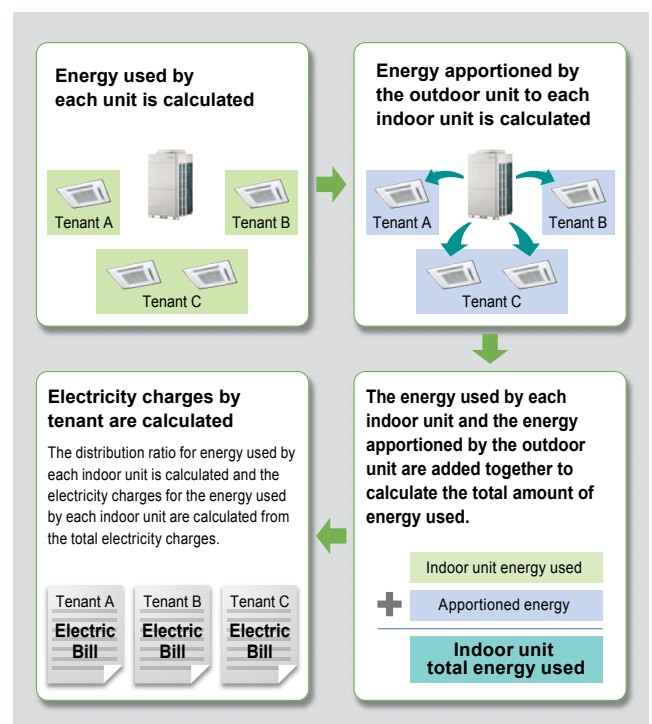
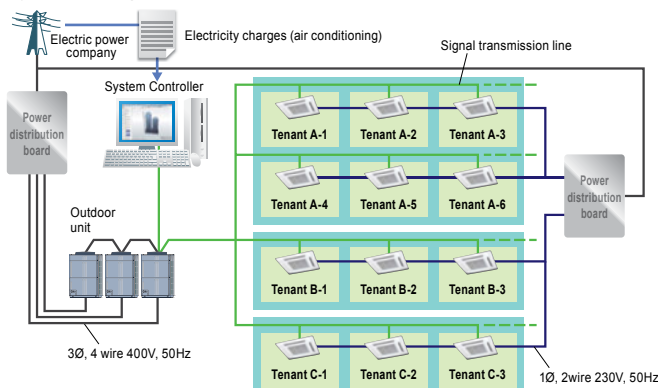

Remote centralized control

System Controller may be used on site or remotely over various networks for remote central control. System Controller requires 2 softwares working together. VRF Controller runs on site and communicate with VRF system. VRF Explorer runs remotely and provides user interface and communicate with the VRF Controller. VRF Controller and VRF Explorer program may run in a single PC or in different PCs separated by network. By using VRF Explorer software, one PC can perform central control of 10 VRF system sites with max. 20 buildings per site.

On site central control

Max. 4 VRF network systems per site

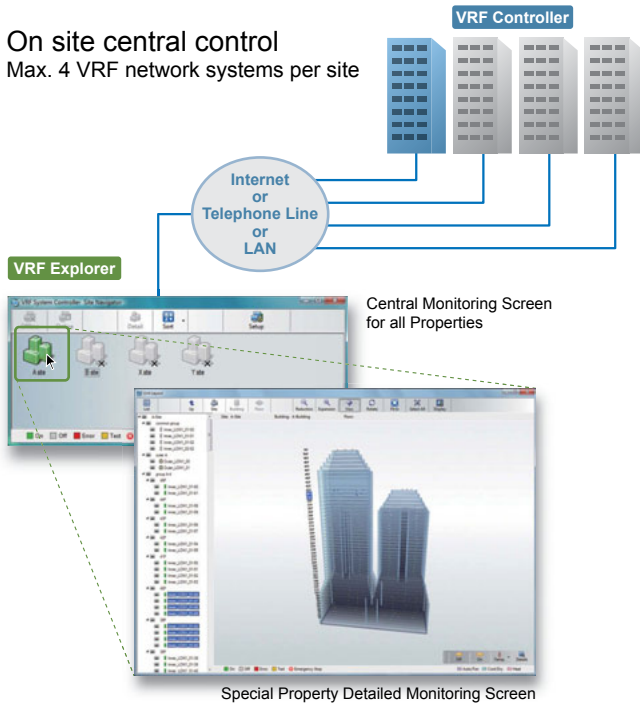

Remote central control

1 VRF Explorer can control or monitor up to 10 sites.

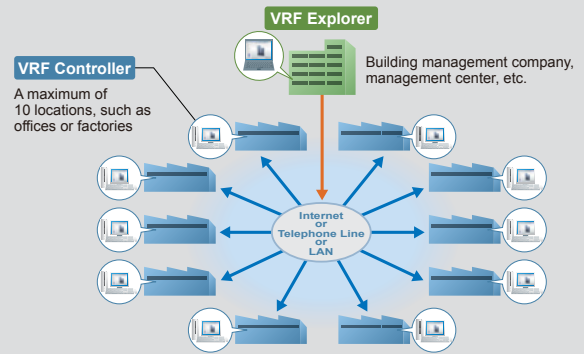

1 VRF Controller can be monitored from any number of VRF Explorers (Up to 5 connections simultaneously).

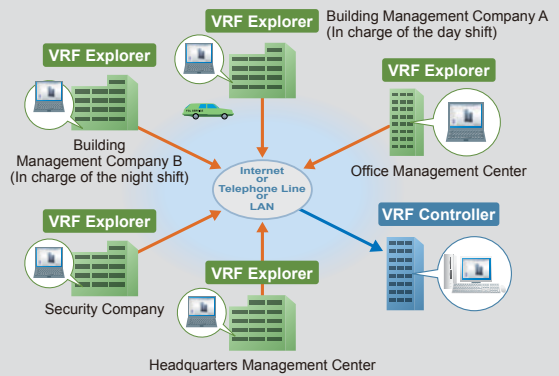

Can be used for a variety of applications

Air conditioning management for large shopping malls or the outlets of nationwide franchises

- Remote centralized management can be used for nighttime only to manage the air conditioning of multiple stores, operate air conditioning for people working overtime, and checking to see if employees forgot to turn off the air conditioning after they leave.
- Multiple users via a LAN can control the air conditioning in the office, general affairs department, or janitor's room.
- The air conditioning for franchise locations nationwide can be centrally controlled from headquarters to facilitate operation status and control to save energy.



Air conditioning management of multiple buildings spread over a large site

- Batched operation of the factory buildings on a large site can be remotely conducted from the management office of the administration building to employ power saving operation.
- The headquarters can conduct centralized remote monitoring of the company's factories in outlying areas to improve the power saving effect for the entire company.
- Controlling the operation of each building and each classroom on campus makes it possible to reduce expenses by remotely controlling those spaces in accordance with the teaching schedule.



Provides high-quality building air conditioning service

- Service companies that manage buildings that are empty at night after the managers leave to go home can conduct centralized remote monitoring of the building without dispatching employees to the site, which allows them to monitor the air conditioning for multiple clients.
- The System Controller remote monitoring and control functions can be used to receive outsourcing business from small and medium size building owners to manage their air conditioning energy.
- Nighttime only remote monitoring of multiple properties after the people leave can be performed for areas that require 24-hour operation, such as server rooms, to monitor for problems.



Security Support

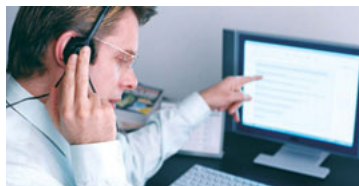

Employs SSL Encryption Technology

Encryption technology is used for communications to remote sites to prevent information from being stolen.



Detailed User Management

User identification : Authorization using user IDs and passwords is employed to prevent unauthorized access.

Access authority : The functions that can be used are restricted for individual login users to prevent unauthorized use.

Schedule control

- Annual schedules can be set for each remote controller group / user defined group.
- Start / stop, operating mode, remote controller prohibition, and temperature settings can be set up to 144 times per day at 10 minute intervals for up to 101 configurations for each remote controller group.
- Settings can be made for periods straddling midnight.
- Allows programming of special settings for holidays, including public holidays, for a complete year.
- Low noise operation of outdoor unit can be scheduled.

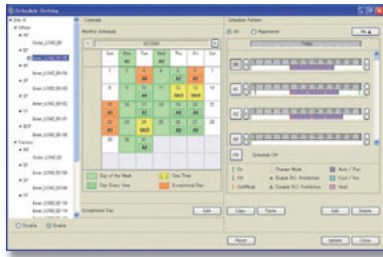

Diverse control of indoor units

- Indoor unit operation state, operation mode, etc. are displayed
- Indoor unit start / stop and operation mode switching
- Temperature setting, Remote Controller prohibition.

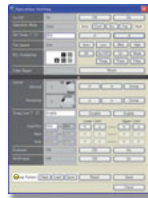

Error display & E-mail notification

Error is notified with popup message, audible sound and E-mail real time when error occurs. Error for the past 1 year are logged and can be reviewed later.

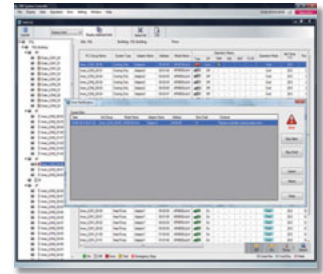

Operating & control record

Displays the history of operation status and control.

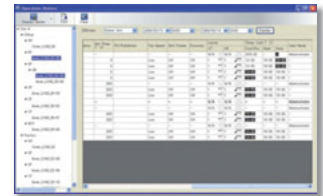

Prohibition Setting

This prohibits changes to the operation mode, temperature, start / stop, etc.

Multiple language display

Corresponds to 7 different languages (English, Chinese, French, German, Spanish, Russian, Polish)

PERSONAL COMPUTER SPECIFICATIONS

The following chart shows the detail requirement for an AT compatible personal computer to run System Controller. Applies for both VRF Controller and VRF Explorer PC.

Operating system	<ul style="list-style-type: none"> • Microsoft® Windows® XP SP3 (32-bit) Professional (*1) • Microsoft® Windows® Vista® SP2 (32-bit) Home Premium, Business (*2) • Microsoft® Windows® 7 SP1 (32/64-bit) Home Premium, Professional (*2) [Supported languages] (*1) English only (*2) English, Chinese, French, German, Russian, Spanish, and Polish
CPU	Intel® Core™ i3 2GHz or higher
Memory	2GB or more (Windows® XP, Vista®, 7 32-bit), 4GB or more (Windows® 7 64-bit)
HDD	40GB or more of free space
Display	1024 x 768 or higher resolution
Interface	USB port is required for each of the followings for Server PC ; <ul style="list-style-type: none"> • Wibu Key (Software protection key) • Echelon® U10 USB Network Interface (Required for each VRF Network) Ethernet port is required for remote connection using internet.
Accelerator	Requires the internal graphics accelerator be compatible with Microsoft® DirectX® 9.0
Software required	Adobe® Reader® 9.0 or later
Hardware required	DVD-ROM Drive

<OPTION AVAILABLE>

Energy Saving Software	UTY-PEGX(*1)	Additional support for energy saving function and Electricity Charge Apportionment using electricity meter.
------------------------	--------------	---

<PACKING LIST>

Name and shape	Quantity	Application
DVD-ROM	1	Includes the software and manuals for System Controller. Both VRF Controller and VRF Explorer software are included.
Wibu Key (Software protection key)	1	Software protection key to be inserted in a USB slot running System Controller. System Controller may only run on a PC with Wibu Key. However, Wibu key is not required for remote VRF Explorer software.

Personal computer must be field supplied. U10 USB Network Interface must be field supplied. Contact Echelon® Corporation or its local sales representative for detail.

Product Name : U10 USB Network Interface - TP/FT-10 Channel Model Number : 75010R

*1: Energy Saving Software (UTY-PEGX) is available for the indoor units and the outdoor units after revision code B or later.

Microsoft® Windows® 8 will be supported.(Future release)

Network Converter

UTY-VGGXZ1

Max. connectable
16
single indoor units

Max. connectable
4
Group Remote Controllers



- This Network Converter is to be used for connecting single split system or Group Remote Controller (UTY-CGGY / UTY-CGGG) with the VRF network system.
- Please select the function by switching the dip switch during the installation.

Functions

Used for connecting single split system

- Split type systems can be centrally controlled from Touch Panel Controller or System Controller through connection to the VRF's network converter.
- On / Off Control, Master control, Room temperature and Fan speed setting via the Network Converter are available.
- One Network Converter can be used to connect and control up to 16 single units.

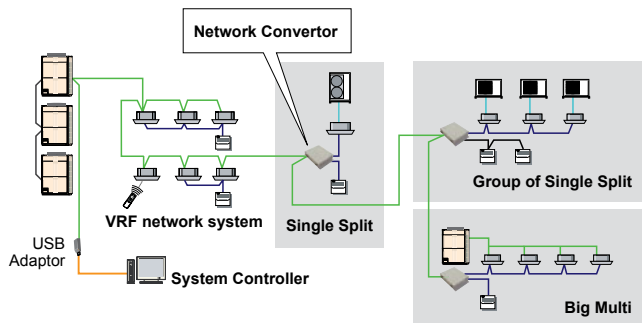

Please consult your distributor for connectable split type air conditioner. Up to 100 Network Converters may be connected in single VRF network system. One Network Converter is considered as a single refrigerant system, irrespective of the number of connected single models.

Used for connecting Group Remote Controller

4 Group Remote Controllers can be connected to a single Network Converter (UTY-VGGXZ1).

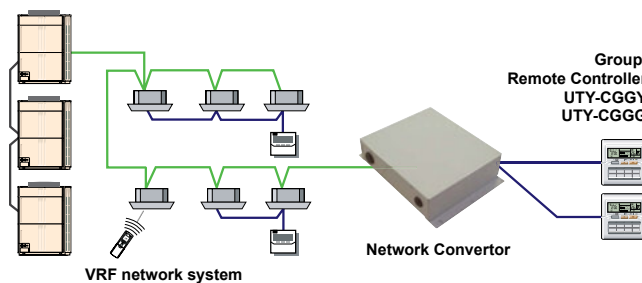

* 2 refrigerant circuits can be covered by a single Network Converter (UTY-VGGXZ1). Up to a total of 16 Network Converters (UTY-VGGXZ1) and System Controller adaptors can be connected in a single VRF network system.

Specifications

Model name	UTY-VGGXZ1
Power Supply	208-240V 50/60Hz, Single phase
Power Consumption (W)	8.5
Dimensions (H x W x D) (mm)	67 x 288 x 211
Weight (g)	1,500

Dimensions (Unit : mm)

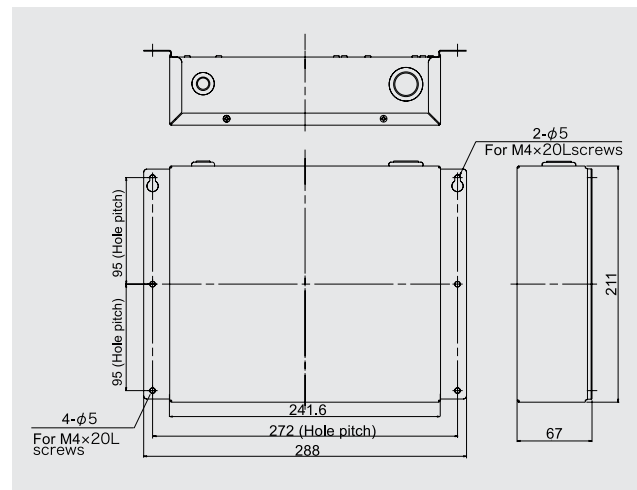

Network Converter for LONWORKS®

UTY-VLGX

Max. controllable
4
Units to BMS

Max. controllable
100
Outdoor units

Max. controllable
128
Indoor units



- For connection between VRF network system and a LONWORKS® open network for management of small to medium-sized BMS and VRF network system.
- The UTY-VLGX permits central monitoring and control of a VRF network system from a BMS through a LONWORKS® interface.
- Up to 128 Indoor units can be connected to one Network Converter for LONWORKS®

Installation example

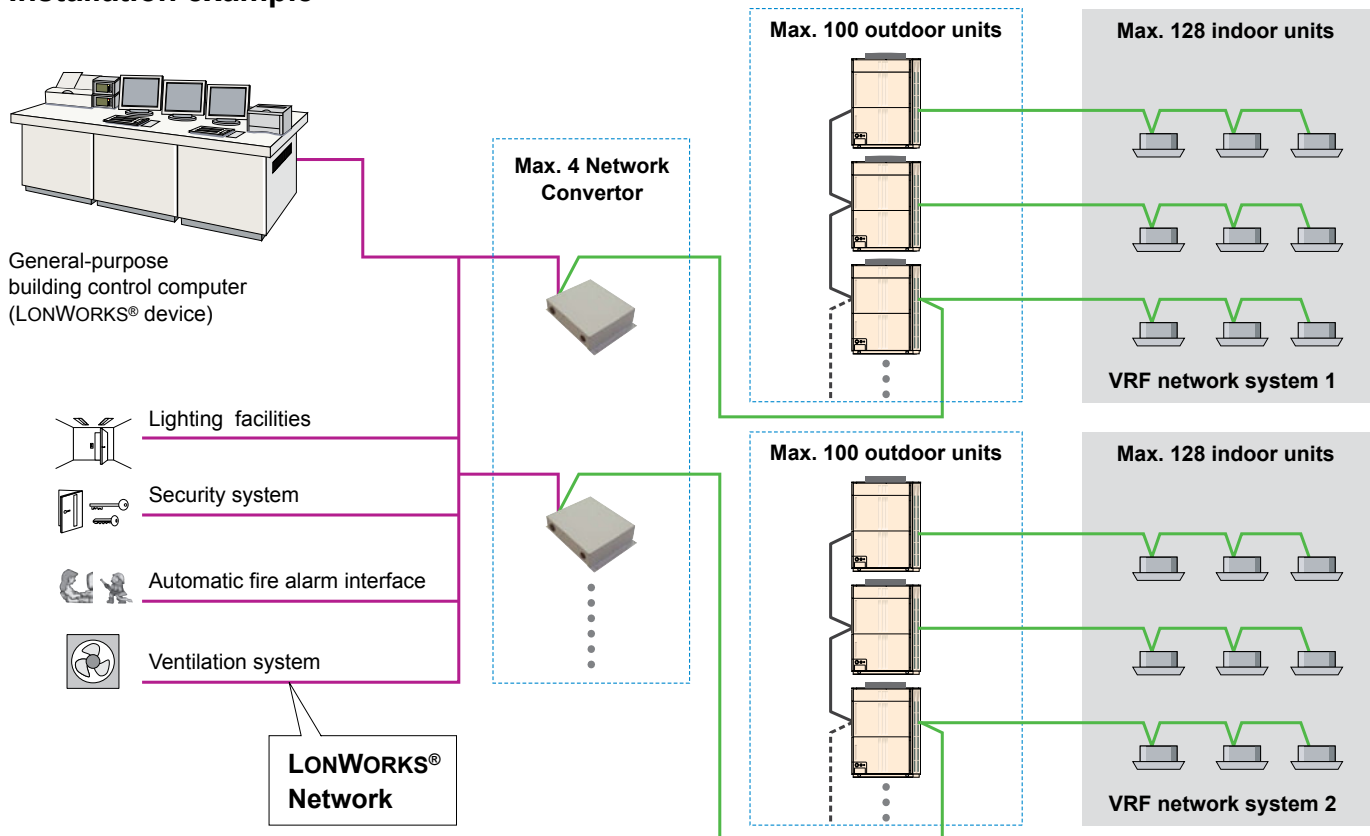

Specifications

Model name	UTY-VLGX
Power Supply	208-240V 50/60Hz, Single phase
Power Consumption (W)	4.5
Dimensions (H x W x D) (mm)	67 x 288 x 211
Weight (g)	1,500

Transmission specifications (BMS side)

Transmission speed	78 kbps
Transceiver	FT-X1 (Echelon® Corporation)
Transmission way form	Free topology
Terminal resistor	None (It attaches at the terminal of a network.)

Dimensions (Unit : mm)

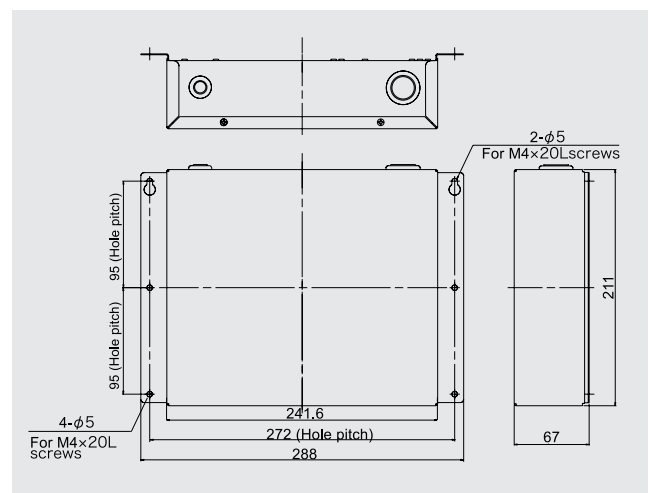

BACnet® Gateway

UTY-ABGX

Software



BACnet is a registered trademark of ASHRAE. ASHRAE does not endorse, approve or test products for compliance with ASHRAE standards. Consultance of Echelon products to requirements of ASHRAE Standard 119 is the responsibility of the BACnet International. BTL is a registered trademark of the BACnet International.

Max. controllable
4
VRF network systems

Max. controllable
400
Outdoor units

Max. controllable
1,600
Indoor units

- It is possible to connect medium to large sized BMS to VRF network system via BACnet®, a global standard for open networks.
- A maximum of 1600 indoor units with 4 VRF network systems (a maximum of 400 indoor units & 100 outdoor units for one network system) can be connected to one BACnet® Gateway.
- It is possible to control or monitor VRF network system from BMS via BACnet® Gateway.
- Compatible with BACnet® (ANSI / ASHRAE-135-2004) application specific controller (B-ASC).
- Compatible with BACnet®/IP over Ethernet.
- Scheduling function, Alarm & Event functions as well as Electricity Change Apportionment function are provided in BACnet® Gateway.
- Connection between VRF network system to personal computer is possible via small U10 USB interface. However, both U10 USB interface & personal computer are field supplied items.
- Corresponds to 7 different languages, English, Chinese, French, German, Spanish, Russian, Polish.

Installation example

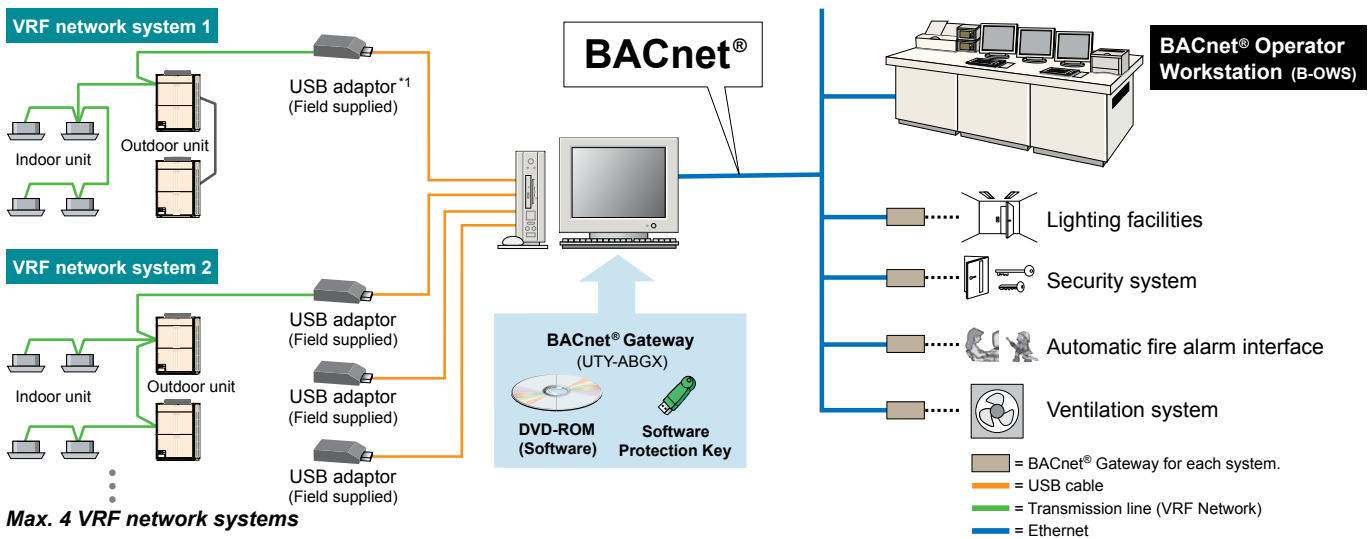

*1: USB adaptor is U10 USB Network Interface of Echelon® Corporation.

PERSONAL COMPUTER SPECIFICATIONS

Operating system	<ul style="list-style-type: none"> • Microsoft® Windows® XP SP3 (32-bit) Professional • Microsoft® Windows® Vista® SP2 (32-bit) Home Premium, Business • Microsoft® Windows® 7 SP1 (32/64-bit) Home Premium, Professional [Supported languages] English, Chinese, French, German, Russian, Spanish, and Polish
CPU	Intel® Core™ i3 2GHz or higher
Memory	2GB or more (Windows® XP, Vista®, 7 32-bit), 4GB or more (Windows® 7 64-bit)
HDD	40GB or more of free space
Display	1024 x 768 or higher resolution
Interface	USB port (x2-5) is required Ethernet port is required
Software required	Adobe® Reader® 9.0 or later
Hardware required	DVD-ROM Drive

<PACKING LIST>

Name and shape	Quantity	Application
DVD-ROM	1	Includes the software and manuals for BACnet® Gateway.
Wibu Key (Software protection key)	1	Software protection key to be inserted in a USB slot running BACnet® Gateway. BACnet® Gateway may only run on a PC with Wibu Key.

Personal computer must be field supplied. U10 USB Network Interface must be field supplied. Contact Echelon® Corporation or its local sales representative for detail.
 Product Name : U10 USB Network Interface - TP/FT-10 Channel Model Number : 75010R
 Microsoft® Windows® 8 will be supported.(Future release)

Signal Amplifier

UTY-VSGXZ1

- Transmission Line length can be extended up to 3,600m with multiple Signal Amplifiers.
- Up to 40 signal amplifiers can be installed in a VRF network system.
- A signal amplifier is required,
 - (1) When the total wiring length of the transmission line exceeds 500m.
 - (2) When the total number of units on the transmission line exceeds 64.



Installation example

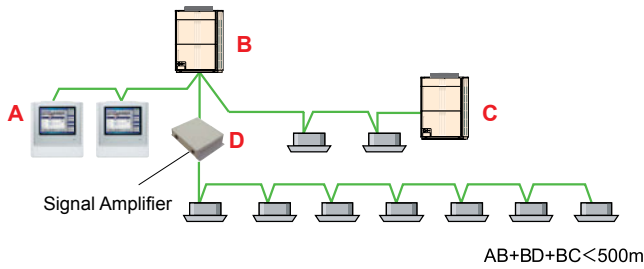

Dimensions (Unit : mm)

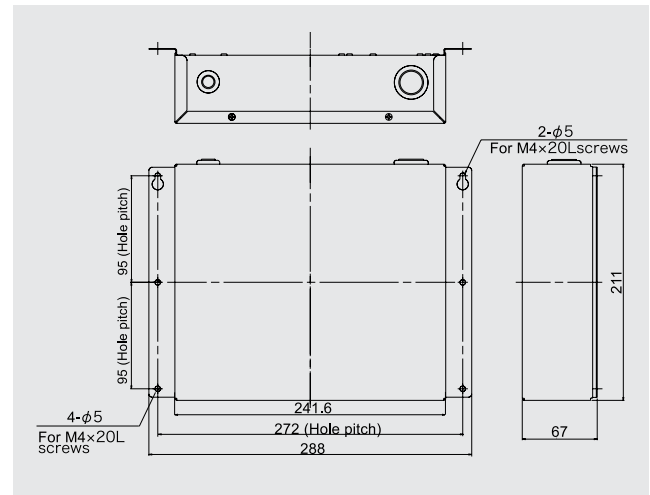

Specifications

Model name	UTY-VSGXZ1
Power Supply	208-240V 50/60Hz, Single phase
Power Consumption (W)	4.5
Dimensions (H x W x D) (mm)	67 x 288 x 211
Weight (g)	1,500

External Switch Controller

UTY-TEKX

Air conditioner switching can be controlled by connecting other sensor switches

- In combination with a field supply Card-Key Switch or other sensor, the External Switch Controller allows control of the ON / OFF, Room temperature, Fan speed and Master control functions. This makes this product suitable for installations such as hotel rooms.
- Card-key or other sensor switches are available as a field supplied parts.

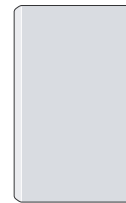

Installation example

Auto mode operation, which switches the cooling and the heating automatically, is enabled by using the sensor switch and External Switch Controller.

Note: All indoor units will operate in the same mode.

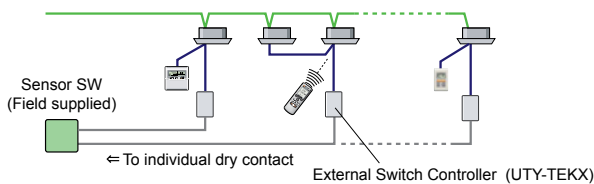
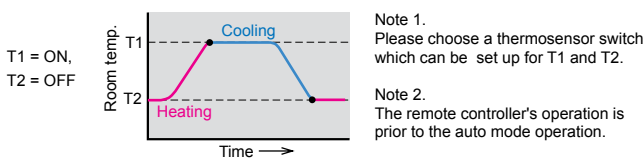

Electrical wiring

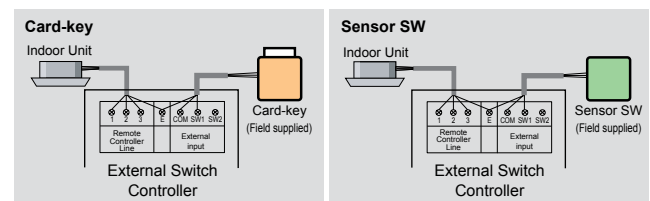

Specifications

Model name	UTY-TEKX
Power Supply	DC 12V
Dimensions (H x W x D) (mm)	120 x 75 x 30
Weight (g)	100

DC12V is supplied by the indoor unit.

Service Tool Software

UTY-ASGX

Max. Monitor
100
Outdoor units

Max. Monitor and control
400
Indoor units



Extensive monitoring and analysis functions for installation and maintenance.

- Operation status can be checked and analyzed to detect even the small abnormalities.
- Data collected and stored on site can be checked later, off-line, off-site for more detail analysis.
- One VRF network system with maximum number of up to 400 units can be monitored and controlled.
- Operation status and various sensor information can be monitored and checked real time in the form of list, refrigerant circuit diagram, graphs as well.
- Simple operation control functions are useful during maintenance.
- The recent error history can be retrieved from units on demand to perform analysis on the cause of the error, after connecting Service Tool to the VRF network system.
- Commissioning tool supports test runs, data storage for each unit and saving of data as CSV files, which may be formatted to create commissioning report.
- Connectable to any point of transmission line with USB adaptor*1 (field supplied)
- Connection between VRF network system to personal computer is possible via small U10 USB interface. However, both U10 USB interface & personal computer are field supplied items.
- 14 advanced functions are available for the VR-II series for through servicing and through shooting.
- The operating state (Solenoid valve) of RB unit can be checked.

* 1: Service Tool (UTY-ASGX) will only support USB type network adaptor and will not support transmission adaptor of the traditional type(UTR-YTMA)

Wiring connection

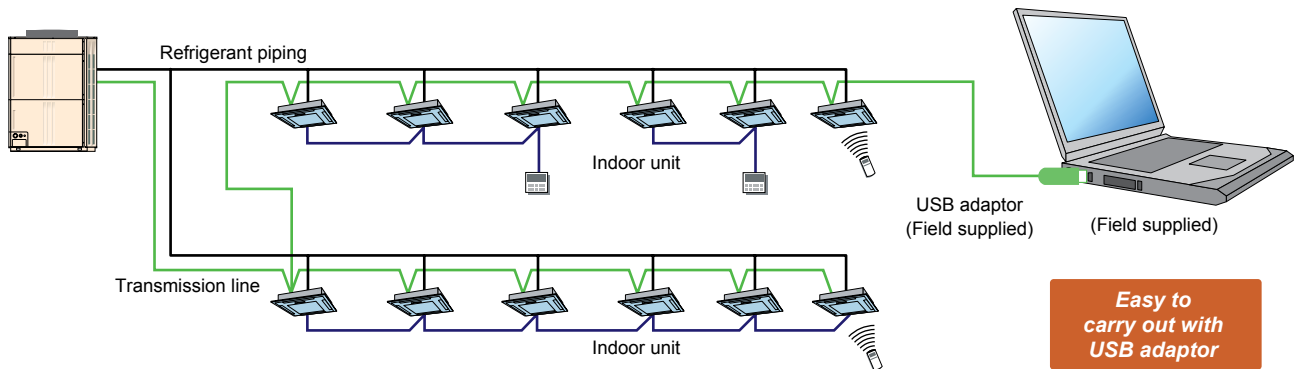

Easy to carry out with USB adaptor

*USB Adaptor is U10 USB Network interface of Echelon® Corporation.

Functions

1) System List

Displays the overall operation status of all or specified units in the system in a list form.

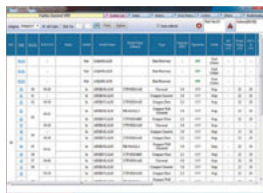

2) Equipment Detail (Diagram)

Displays the detail information for sensor values, electrical components etc. for the specified units in schematic. The information here can be used along with the detail information in list form, to check the operation status of units and make detail analysis on the cause, in case an error occurs.

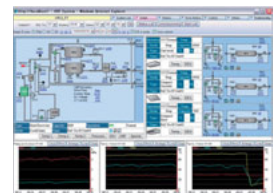

3) Equipment Detail (List)

Displays the detail information for sensor values, electrical components etc. of units in a specified refrigerant system in list form. The information here can be used along with the detail information in diagram form, to check the operation status of units and make detail analysis on the cause, in case an error occurs.

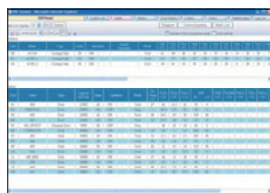

4) Operation History

The indoor units or outdoor unit operation history can be recorded. The displayed operation history can be printed out and saved to a CSV file.

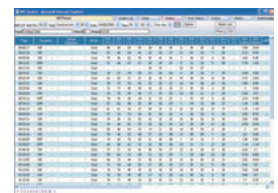

5) Error History

Displays the error information for each unit. The error information can sequentially be displayed up to 50 items as they occur starting with the latest error.

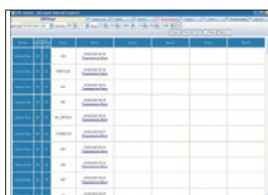

6) Remote File Download

Operation and error history data can be downloaded. Only the required data may be downloaded specifying the refrigerant system, unit and time range.

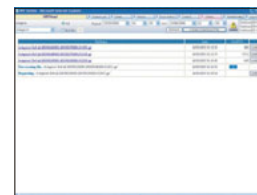

7) Commissioning Tool

Test run commands can be executed with this tool. During test running, the outdoor unit / indoor unit sensor data can be saved (commissioning log data). After the end of test running, this data can be exported in CSV file format.

8) Network Topology Analyzer *

A list of units connected to the VRF system network is displayed in network segments in tree form.



9) Remote Setting *

Function (Field) Setting for indoor unit is realized remotely

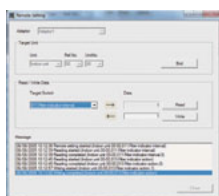

10) System Time Setting *

An arbitrary time is set for all the remote controllers within the system.

11) Central Release *

The operation setting restriction function of the indoor units set from the controller can be forcibly released. (remote controller inhibit, temperature upper/lower limit setting)

12) Model Name Writer *

An arbitrary model name can be written to the target unit.

13) Error Memory Reader *

When an error occurs at an outdoor unit, the operation data records before the error are acquired over a network and saved to a CSV file.

14) Time Guard Information *

Reference data for judging the maintenance period of indoor and outdoor units (compressor, FAN, etc. integrated time) is output to a CSV file.

Note: To perform "Error Memory Reading", Service Tool and the corresponding outdoor unit must be connected directly with each other. Refer to the Operation Manual of the Service Tool for detail.

*: Supported by Ver. 1.1 or later

PERSONAL COMPUTER SPECIFICATIONS

Operating system	<ul style="list-style-type: none"> Microsoft® Windows® XP SP3 (32-bit) Professional Microsoft® Windows® Vista® SP2 (32-bit) Home Premium, Business Microsoft® Windows® 7 SP1 (32/64-bit) Professional [Supported languages] English only
CPU	1GHz or higher
Memory	512 MB or more (Windows® XP 32-bit) 1GB or more (Windows® Vista®, 7 32-bit) 2GB or more (Windows® 7 64-bit)
HDD	10GB or more of free space
Display	1024 x 768 or higher resolution
Interface	USB port for U10 USB Network Interface and Software protection key
Software required	Internet Explorer 7.0 or 8.0 or 9.0 / Adobe® Reader® 9.0 or later
Hardware required	DVD-ROM Drive

<PACKING LIST>

Name and shape	Quantity	Application
DVD-ROM	1	Includes the software and manuals for Service Tool.
Wibu Key (Software protection key)	1	Software protection key to be inserted in a USB slot running Service Tool. Service Tool may only run on a PC with Wibu Key.

Personal computer must be field supplied. U10 USB Network Interface must be field supplied. Contact Echelon® Corporation or its local sales representative for detail.
Product Name : U10 USB Network Interface - TP/FT-10 Channel Model Number : 75010R
Microsoft® Windows® 8 will be supported.(Future release)

Web Monitoring Tool

Software

UTY-AMGX

4
VRF network systems can be supported

Max. Monitor
400
Outdoor units

Max. Monitor and control
1600
Indoor unit can be monitored

Product features

- Troubleshooting is performed by monitoring each unit remotely during periodical system checks off-site.
- Operation status can be checked and analyzed to detect even the smallest abnormalities.
- Four VRF network systems each with 400 units, with maximum number of up to 1,600 units can be monitored and controlled.
- Operation status and various sensor information can be monitored and checked real time in the form of list, refrigerant circuit diagram, and graphs as well.
- The monitoring data in a remote side can be optionally downloaded. And, this data can be displayed in off-line mode of the Service Tool.
- Error notification can be automatically transmitted to several locations using the internet*1.
- Monitoring side computer is not required to install special software, requires only general web browser.
- Connectable to any point of transmission line with U10 USB interface*2 (field supplied)
- Connection between VRF network system to personal computer is possible via small U10 USB interface. However, both U10 USB interface & personal computer are field supplied items.
- The operating state (Solenoid valve) of RB unit can be checked.

* 1: USB of internet mail system required.

* 2: Web Monitoring Tool (UTY-AMGX) will only support USB type network adaptor and will not support transmission adaptor of the traditional type (UTR-YTMA).

Web Monitoring System

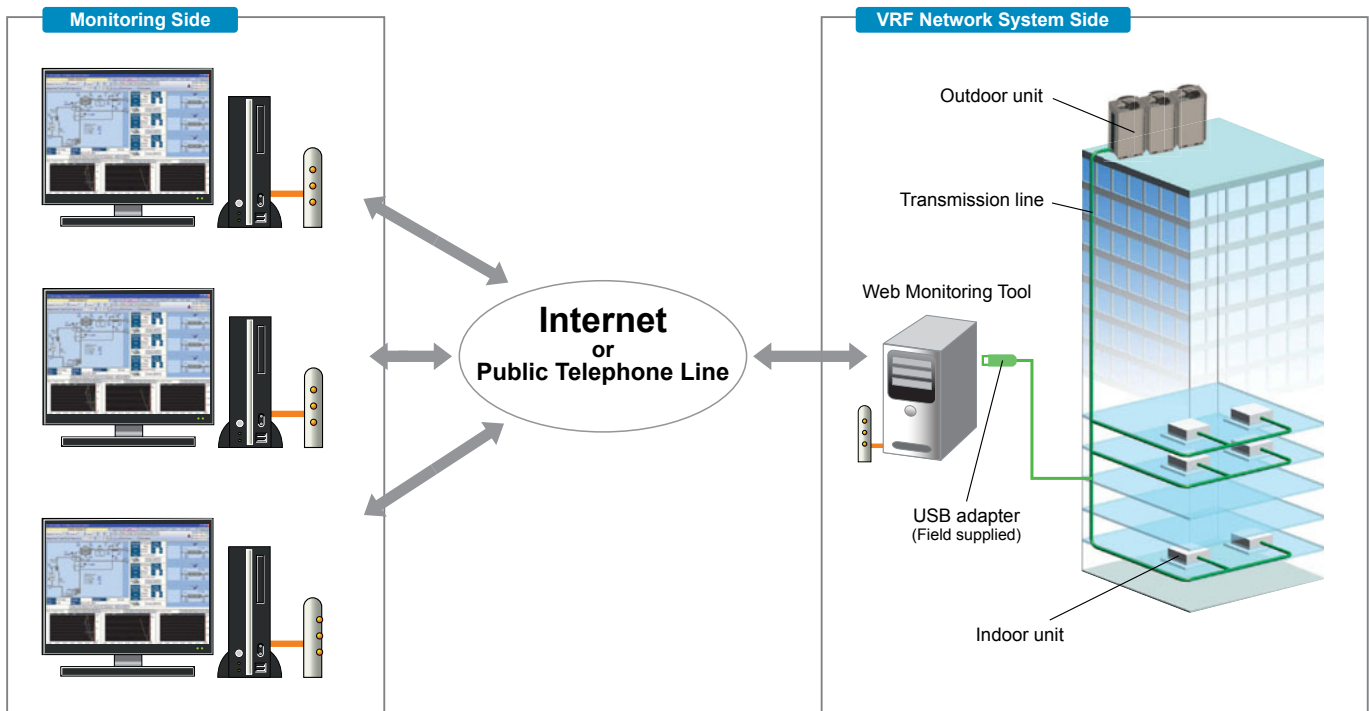

System components

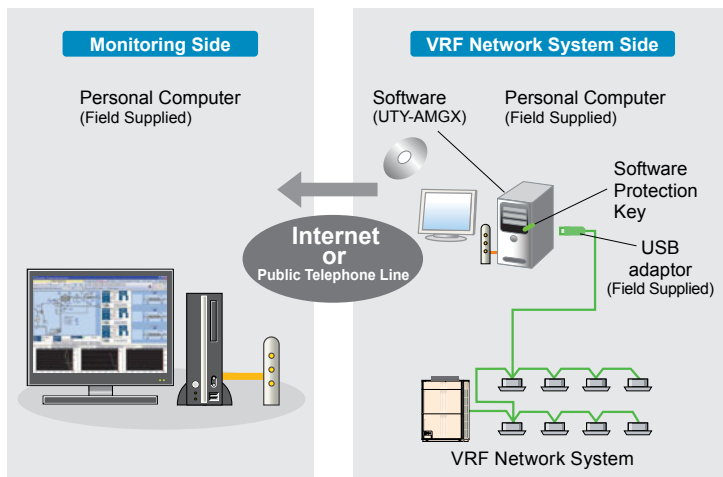

Support 4 VRF network systems

USB adaptor (max. 4 adaptors per PC) permit, monitoring of up to 1,600 indoor units.

Suitable for large-scale buildings or hotels.

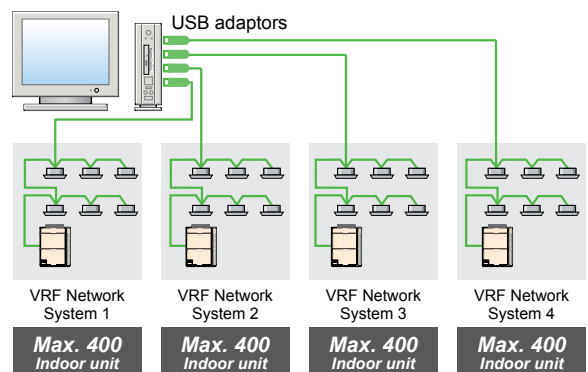

COMPARISON TABLE

No.	Item	Service Tool UTY-ASGX	Web Monitoring Tool UTY-AMGX	
			VRF network system Side	Monitoring Side
1	Interchangeability of equipment	●	●	●
2	Indication of equipment list	●	●	●
3	Operation control	●	●	—
4	Indication of refrigerant circuit diagram	●	●	●
5	Commissioning tool	●	●	—
6	Monitoring of equipment information	●	●	●
7	Monitoring of operating condition	●	●	●
8	Monitoring of sensor data	●	●	●
9	Storage and CSV output of operating history (sensor data)	●	●	●
10	Indication of trend graph	●	●	●
11	Printing of trend graph	●	●	●
12	Monitoring and screen display of abnormalities	●	●	●
13	E-mail automatic transmission of abnormalities	—	● ^{*1}	—
14	Setting for user level	—	●	—
15	Network Topology Analyzer *	●	●	—
16	Remote Setting *	●	●	—
17	System Time Setting *	●	●	—
18	Central Release *	●	●	—
19	Model Name Writer *	●	—	—
20	Error Memory Reader *	●	—	—
21	Time Guard Information *	●	●	●

*: Supported by Ver. 1.1 or later

*1: it is available only during a connection to the Internet.

PERSONAL COMPUTER SPECIFICATIONS

Operating system	<ul style="list-style-type: none"> Microsoft® Windows® XP SP3 (32-bit) Professional Microsoft® Windows® Vista® SP2 (32-bit) Home Premium, Business Microsoft® Windows® 7 SP1 (32/64-bit) Professional [Supported languages] English only
CPU	1GHz or higher
Memory	1GB or more (Windows® XP, Vista®, 7 32-bit) 2GB or more (Windows® 7 64-bit)
HDD	40GB or more of free space
Display	1024 x 768 or higher resolution
Interface	USB port (for U10 USB Network Interface Max.4 , Software protection key) Either of the following interface is required for remote connection: <ul style="list-style-type: none"> Public Telephone Line : Modem is required Internet using LAN : Ethernet port is required
Software required	Internet Explorer 7.0 or 8.0 or 9.0 / Adobe® Reader® 9.0 or later
Hardware required	DVD-ROM Drive

<PACKING LIST>

Name and shape	Quantity	Application
DVD-ROM	1	Includes the software and manuals for Web Monitoring Tool.
Wibu Key (Software protection key)	1	Software protection key to be inserted in a USB slot running Web Monitoring Tool. Web Monitoring Tool may only run on a PC with Wibu Key.

Personal computer must be field supplied. U10 USB Network Interface must be field supplied. Contact Echelon® Corporation or its local sales representative for detail.

Product Name : U10 USB Network Interface - TP/FT-10 Channel Model Number : 75010R

Microsoft® Windows® 8 will be supported.(Future release)

Energy Recovery Ventilator

Models

- UTZ-BD025B**
- UTZ-BD035B**
- UTZ-BD050B**
- UTZ-BD080B**
- UTZ-BD100B**



Energy recovery ventilator unit offers maximum comfort and greater energy savings.

Heat exchange ventilation and normal ventilation

Heat exchange ventilation

When a room is cooled or heated, the exhausted cooling / heating energy is recovered by heat-exchange ventilation.

Normal ventilation

This is used in spring and autumn, when rooms are not cooled or heated, that is, when there is little difference between the indoor and outdoor air conditions. In addition, at night during the hot season, when the outside air temperature drops the outside air is drawn inside without heat exchange, alleviating the load on the air conditioning equipment.

Adopts a highly efficient counter-flow heat exchange element

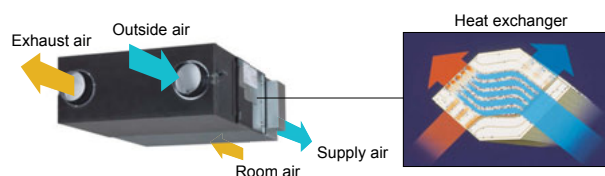

Specifications

Rated flow rate				250 m³/h	350 m³/h	500 m³/h	800 m³/h	1000 m³/h
Model No.				UTZ-BD025B	UTZ-BD035B	UTZ-BD050B	UTZ-BD080B	UTZ-BD100B
Power source				220 - 240V, 50Hz				
HEAT EXCHANGE VENTILATION	Input power	Extra high / High / Low	W	128 / 123 / 96	190 / 185 / 168	289 / 225 / 185	418 / 378 / 295	464 / 432 / 311
	Air flow rate	Extra high / High / Low	m³/h	250 / 250 / 190	350 / 350 / 240	500 / 500 / 440	800 / 800 / 630	1000 / 1000 / 700
	External static pressure	Extra high / High / Low	Pa	105 / 95 / 45	140 / 60 / 45	120 / 60 / 35	140 / 110 / 55	105 / 80 / 75
	Temperature Exchange Efficiency	Extra high / High / Low	%	75 / 75 / 77	75 / 75 / 78	75 / 75 / 76	75 / 75 / 76	75 / 75 / 79
	Energy Exchange Efficiency Cooling	Extra high / High / Low	%	63 / 63 / 65	66 / 66 / 71	62 / 62 / 64	65 / 65 / 68	65 / 65 / 70
	Energy Exchange Efficiency Heat pump	Extra high / High / Low	%	70 / 70 / 72	69 / 69 / 73	67 / 67 / 69	71 / 71 / 74	71 / 71 / 76
Sound pressure level	Extra high / High / Low	dB*	31.5 / 30.5 / 26.5	33 / 31 / 25.5	37.5 / 35.5 / 32.5	37.5 / 37 / 34.5	38.5 / 37.5 / 34.5	
NORMAL VENTILATION	Input power	Extra high / High / Low	W	128 / 123 / 96	190 / 185 / 168	289 / 225 / 185	418 / 378 / 295	464 / 432 / 311
	Air flow rate	Extra high / High / Low	m³/h	250 / 250 / 190	350 / 350 / 240	500 / 500 / 440	800 / 800 / 630	1000 / 1000 / 700
	External static pressure	Extra high / High / Low	Pa	105 / 95 / 45	140 / 60 / 45	120 / 60 / 35	140 / 110 / 55	105 / 80 / 75
	Sound pressure level	Extra high / High / Low	dB*	31.5 / 30.5 / 26.5	33 / 31 / 25.5	38.5 / 38 / 32.5	37.5 / 37 / 34.5	40.5 / 39.5 / 36.5
Dimensions (W × D × H)		mm	882 × 599 × 270	1050 × 804 × 317	1090 × 904 × 317	1322 × 884 × 388	1322 × 1134 × 388	
Weight		kg	29	49	57	71	83	
Outlet duct diameter		mm	150	150	200	250	250	
Operation range		°C	-10 ~ 40	-10 ~ 40	-10 ~ 40	-10 ~ 40	-10 ~ 40	
Maximum humidity		%	85	85	85	85	85	

* The noise level must be measured 1.5 m below the centre of the unit.

Energy efficiency and ecology

Energy consumption is dramatically reduced by using a counterflow heat-exchange element. Air conditioning load is reduced by approximately 20%, resulting in significant energy savings. Recovers up to 77% of the heat in the outgoing air.

20%
Energy saving

Features of heat exchange element

With the cross-flow element, air moves in a straight line across the element. With the counter-flow element, air flows through the element for a longer time (longer distance), so the heat-exchange effect remains unchanged.

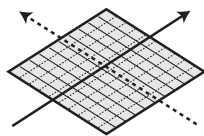

Other element
(Cross-flow element)

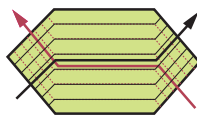

Fujitsu element
(Counter-flow element)

Quiet operation

Significantly reducing low pressure loss and noise allows low-noise operation.

Extended range of an external static pressure

An external static pressure is improved by adopting a powerful fan motor.

This allows for application in a wide variety building.

Slim shape and easier installation

Counter-flow heat exchange element used for reduced noise and slimmer, more compact body shape.

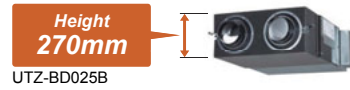

UTZ-BD025B

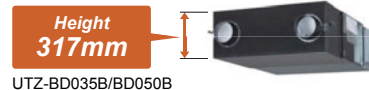

UTZ-BD035B/BD050B

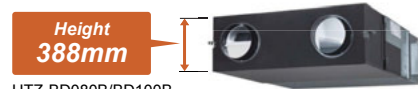

UTZ-BD080B/BD100B

Reverse mountable direct air supply / exhaust system

Adoption of straight air supply / exhaust system: Duct design is simplified because the air supply / exhaust ducts are straight.

Since each unit can be mounted in reverse position, only one inspection hole is needed for two units: Two units can share one inspection hole so duct work is easier and more flexible.

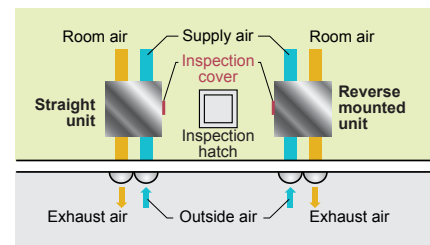

Dimensions (Unit : mm)

Models: UTZ-BD025B / UTZ-BD035B / UTZ-BD050B / UTZ-BD080B / UTZ-BD100B

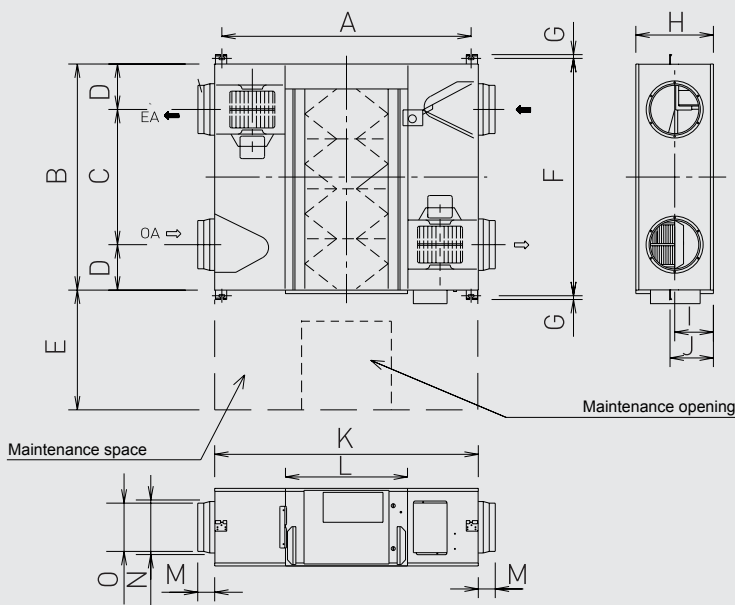

	UTZ-BD025B	UTZ-BD035B	UTZ-BD050B	UTZ-BD080B	UTZ-BD100B
A	810	978	1018	1250	1250
B	599	804	904	884	1134
C	315	580	640	428	678
D	142	112	132	228	228
E	600	600	600	600	600
F	655	860	960	940	1190
G	19	19	19	19	19
H	270	317	317	388	388
I	135	159	159	194	194
J	159	182	182	218	218
K	882	1050	1090	1322	1322
L	414	470	470	612	612
M	95	70	127	85	85
N	219	162	210	258	258
O	144	144	194	242	242

Auto Louver Grille Kit (Option)

Models

- UTD-GXSA-W**
- UTD-GXSB-W**
- UTD-GXSC-W**

Simple flat Auto Louver will provide comfort airflow and harmonize with luxury interior.



Flexible Control

- **Operation with indoor unit**
Auto Louver can be operated by synchronizing remote controller of indoor unit.
- **UP and Down auto swing**
 - Auto airflow direction and auto swing
 - 4 steps selectable
- **Auto-closing louver**
When operation of indoor unit is stopped, the louver will automatically close.

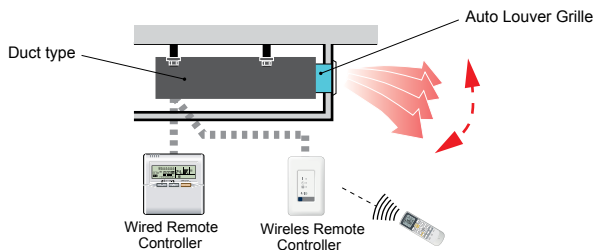

Dimensions

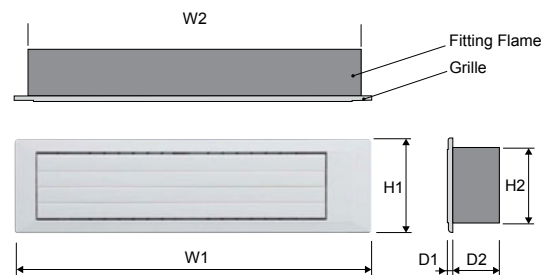

Unit: mm

Model Name	W1	W2	H1	H2	D1	D2
UTD-GXSA-W	683	645	180	148	9	84
UTD-GXSB-W	883	845				
UTD-GXSC-W	1,083	1,045				

Specifications

Model name			UTD-GXSA-W	UTD-GXSB-W	UTD-GXSC-W
Applicable Indoor Unit			ARXD07/09/12/14GALH	ARXD18GALH	ARXD24GALH
Power Supply			Connecting with Control box of indoor unit		
Fixing of Auto Louver Grille			Screw fixing to Flange or Square Duct		
Extension Square Duct Limit			1.0m (Max. duct length between indoor unit and Grille)		
Net Dimension (H x W x D)		mm (inch)	180x683x(84+9) [7-3/32x26-7/8x(3-5/16+11/32)]	180x883x(84+9) [7-3/32x34-3/4x(3-5/16+11/32)]	180x1083x(84+9) [7-3/32x42-5/8x(3-5/16+11/32)]
Weight	Net	kg (lb.)	2.0 (4.4)	2.5 (5.6)	3.0 (6.7)
	Gross		3.0 (6.7)	3.5 (7.8)	4.0 (8.9)
Color			White		
Louver Motor			Stepping Motor		
Accessories			Fitting Flame, etc.		
Operation range	Cooling	°C (°F)	18 to 32 (64 to 90)		
		% RH	80% or less		
	Heating	°C (°F)	16 to 30 (60 to 88)		

Building Information Modeling (BIM)

FUJITSU provides the Building Information Modeling (BIM) object models and contents for our VRF system and some products to the architect, designer and contractor using Autodesk® Revit® technology from our Website and Autodesk® Seek Website, etc.

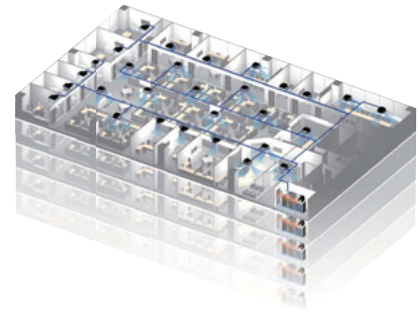

BIM Object Models Ensure Proper Design

Many products available

We provide BIM data for indoor units, outdoor units, and accessories. We will continue to create and provide products to support the global market. Object models: VRF "AIRSTAGE V-II" / 8 Rooms Multi "HFI" / Energy Recovery Ventilator Files : Indoor units 75 files / Outdoor units 22 files / Options 15 files

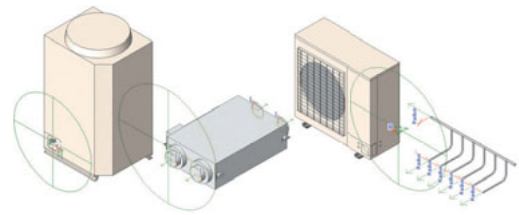

3D and 2D product data

We provide 3D data that is similar to the product appearance. 2D CAD design operations are supported and 2D display is also provided. The data can also be output in other formats, such as DXF and DWG, which are used by other design CAD.

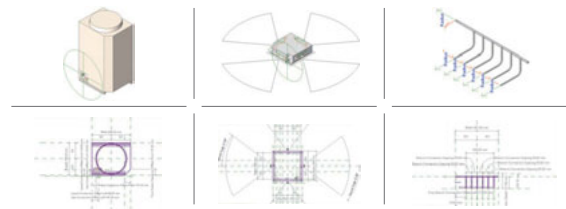

Installation limitation

The equipment installation limitation range is shown. The distance range from the wall, etc., is automatically displayed to make it easy to provide highly reliable layout designs.

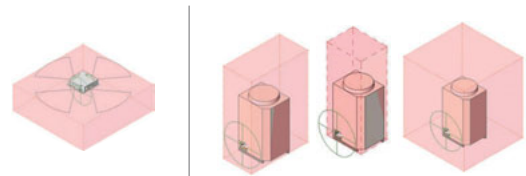

Installation information

Other information, such as symbols showing the airflow direction that are required for installation drawings, is built in and can be automatically reflected in 2D drawings. Installation drawings can be created easily.

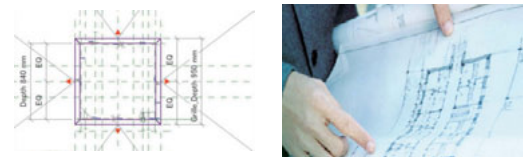

Product specifications & Link information

Contains the basic information required for air conditioner design, including unit size, capacity, input power, noise, and airflow rate.

*: URL: <http://airstage.fujitsugeneral.com>

Data volume

Fujitsu Revit® files are small, requiring very little system resources.

Required software

Autodesk® Revit® series software	Data format
•Autodesk® Revit® Architecture	•RFA
•Autodesk® Revit® MEP	
•Autodesk® Revit® Structure	

Product parameter	Link
Power source Input power Capacity Airflow rate Sound pressure level Dimensions Weight Connection pipe diameter Refrigerant Material/Color	FUJITSU GENERAL Website*

*: URL:<http://www.fujitsu-general.com/index.html>

Design Simulator

Enter your requirements, select your controls and options, design your layout and let the program do the rest.

Put the charts and pens away and design your projects on your computer with ease using the Design Simulator. Everything from selecting indoor and outdoor units, allocating controls and optional parts to designing the piping and wiring systems is made easier using the program's built-in features. Once your project is designed take advantage of the Export functions to easily get materials lists, product specifications, refrigerant calculations and more - it'll even export to Word or Excel formats, and group the relevant CAD data for your project.

1) Input Project Details

Enter the details of the project (optional)



2) Selection of Series

Select which series of equipment you are after, systems which share common units are grouped together.



3) Select Indoor units

Enter the Indoor Unit Requirements and conditions - then use automatic or manual selection to determine the unit to suit your needs.

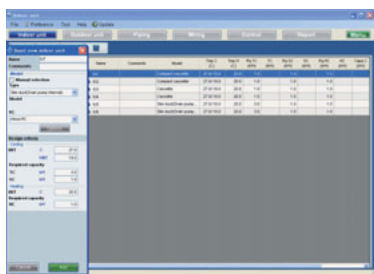

4) Select Outdoor Units

Add Indoor units to each system, then determine the Outdoor unit to suit your needs. If indoors in Step 3 were selected using Auto selection, Step 4 may reselect these indoors to suit the actual capacity

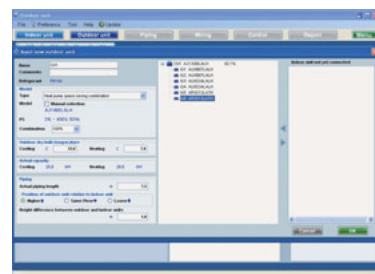

5) Piping Diagram / Input piping lengths

Piping diagrams are automatically created for each refrigerant system and information for each unit is automatically displayed. When the piping lengths are added the refrigerant charge is calculated and any additional refrigerant is shown.

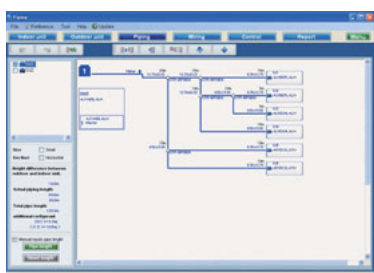

6) Wiring Diagram / Grouping of Remote Controllers

Wiring and remote control diagrams are automatically created for each refrigerant system. Set remote controller groups and addition of unit accessories and optional parts here.

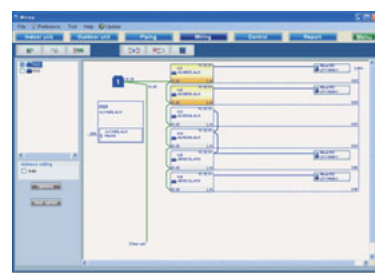

5) Central Controller and Converter options

Select any central controllers and converters that are to be used on the system. There is an Auto function available to let the program determine home many of each control you require for the system as designed.



8) Display and Export Project Report

View materials list for the project. Select which components are to be included into report and then export as csv, rtf or dxf format. You can also include the CAD data in your export to suit the models on your project - in 2D DXF or 3D RFA formats.

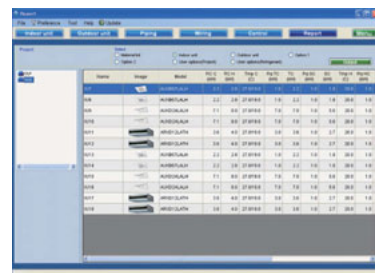

*For further assistance, follow the link in the program to the online Movie Manual to view step by step explanations of all you need to know.

Select Your Preferences

Select your language, region, default unit names and your preferred units of measurement. The program will then perform the required calculations and return the results in the format you want to see. Once this is done once, the program will remember your choices for future use.

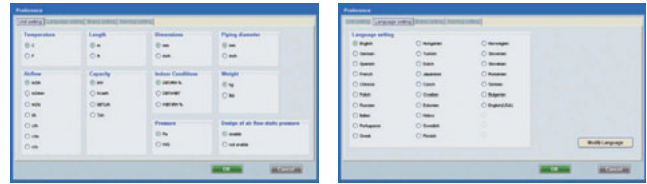

Update your Design Simulator

The information specific to your project can be exported in a number of industry standard file formats.

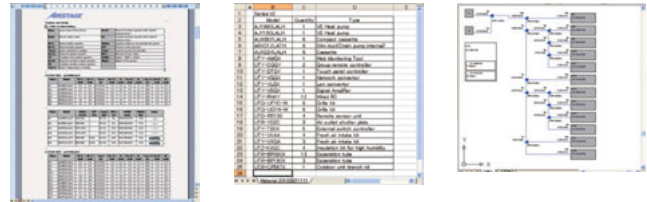

- Word format (rtf)
- Excel format (csv)
- AutoCAD format (DXF)
- 2D Data (DXF)
- 3D Data (RFA)

Update your Design Simulator

Database can be easily updated online using AutoUpdate function through FTP. Once you hit update, the program will connect to the online server and tell you if a newer version is available.

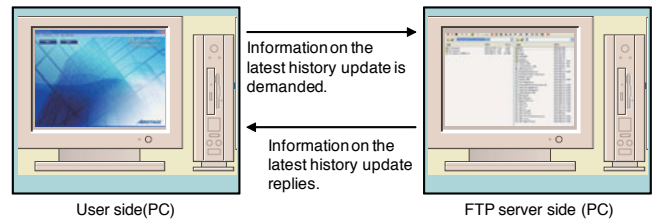

Installation Requirements

Software	Design Simulator	
Operating System	Microsoft Windows XP / Vista / 7	
System Requirements	Hardware	CPU: 500 MHz or faster
		Memory: 2GB (Vista/7) 512MB (XP) or more HDD: 1GB or more
	Display	Resolution: 1024 x 768 or higher
	Software	Internet Explorer 7.0 or newer Adobe Reader 9.0 or newer Microsoft Word 2003 or newer



Program Features and Specifications

Preferences	Language	Choose from 26 different languages
	Brand Setting	Select Fujitsu or General for products specific to your region
	Unit Naming	Choose default name for automatic naming of Indoor and Outdoor Units. i.e. Indoor = FCU, IU or AC. Outdoor = CU or OU
	Measurement Unit Setting	Set your preferred measurement units for Temperature, Unit and Piping Size, Weight, Capacity and Airflow
Model Selection Options	Automatic Selection for Indoor Units, Outdoor Units, Piping and Wiring using the criteria you enter	
	Manually select the units of your choice	
	Select from suggested Optional parts to suit your systems Select from Controllers / Adapters / Convertors for your project	
System Design	Automatic creation of piping and wiring diagrams for the systems you designed	
	Modify the piping and wiring diagrams to suit your specific installation	
Project and Model Information	Materials List	
	Product Detail (Specifications, Options, Photographs)	
	Piping and Wiring Diagrams	
	Additional Refrigerant Calculation automatic when piping lengths are entered CAD Data for models specific to your project in 2D - DXF or 3D RFA formats	
Report Export Formats	Word (RTF format)	
	Excel (CSV format)	
	DXF format	
Update Options	Automatic Update via FTP through internet (AutoUpdate button)	
	Download the latest version of the program if AutoUpdate is unavailable due to firewall etc	

Note: Models are added and updated constantly, specifications are subject to change without notice.
Update your system to ensure you have the latest information.





Optional Parts

Controllers

<p>Wired Remote Controller (Touch Panel) UTY-RNR*</p> 	<p>Wired Remote Controller UTY-RNK*</p> 	<p>Simple Remote Controller UTY-RSK* With operation mode</p> 
<p>Simple Remote Controller UTY-RHK* Without operation mode</p> 	<p>Wireless Remote Controller UTY-LNH*</p> 	<p>IR Receiver Unit UTB-YWC</p>  <p>For All Duct type</p>
<p>IR Receiver Unit UTY-LRH*B1</p>  <p>For Cassette type</p>	<p>Group Remote Controller UTY-CGG*</p> 	<p>Central Remote Controller UTY-DCG*</p> 
<p>Touch Panel Controller UTY-DTG*</p> 	<p>System Controller Software UTY-APGX</p> 	

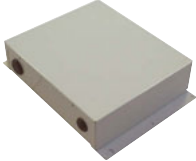
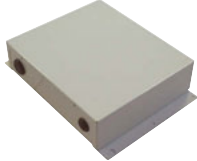
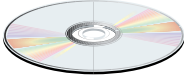
R*: RY (FUJITSU), RG (GENERAL) K*: KY (FUJITSU), KG (GENERAL) H*: HY (FUJITSU), HG (GENERAL) G*: GY (FUJITSU), GG (GENERAL)

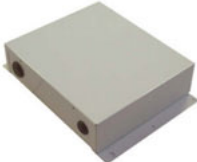
Convertors / Adaptors



















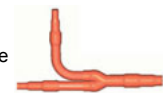

<p>Network Converter UTY-VGGXZ1</p> 	<p>Network Converter for LONWORKS® UTY-VLGX</p> 	<p>BACnet® Gateway Software UTY-ABGX</p>   <p>DVD-ROM (Software) Software Protection Key</p>
<p>Signal Amplifier UTY-VSGXZ1</p> 	<p>External Switch Controller UTY-TEKX</p> 	

Others

<p>Flange (Round) UTD-RF204</p> <p>For Low Static Pressure Duct type / Medium Static Pressure Duct type / Ceiling type</p> 	<p>Flange (Square) UTD-SF045T</p> <p>For Low Static Pressure Duct type / Medium Static Pressure Duct type</p> 	<p>Remote Sensor Unit UTY-XSZX</p> <p>For All Duct type</p> <p>New amenity space can be offered by installing the Remote sensor.</p> 
<p>Long-Life Filter UTD-LF25NA</p> <p>For Low Static Pressure Duct type / Medium Static Pressure Duct type</p> 	<p>Long-Life Filter UTD-LF60KA</p> <p>For High Static Pressure Duct type (ARXC36/45/60GATH)</p> 	<p>Auto Louver Grille Kit UTD-GXSA-W (for ARXD07/09/12/14GALH) UTD-GXSB-W (for ARXD18GALH) UTD-GXSC-W (for ARXD24GALH)</p> <p>For Slim Duct type</p> 
<p>Drain Pump Unit UTZ-PX1BBA</p> <p>For Low Static Pressure Duct type</p> <p>UTZ-PX1NBA</p> <p>For Low Static Pressure Duct type / Medium Static Pressure Duct type</p> 	<p>Drain Pump Unit UTR-DPB24T</p> <p>For Ceiling type</p> 	<p>Wide Panel UTG-AGYA-W</p> <p>For Cassette type</p>  <p>Indoor unit 950 Panel 600 600 (mm)</p>
<p>Air Outlet Shutter Plate UTR-YDZB</p> <p>For Compact Cassette type</p> <p>Shuts the air outlet when only using as 3 blow out.</p> 	<p>Air Outlet Shutter Plate UTR-YDZC</p> <p>For Cassette type</p> <p>Shuts the air outlet when only using as 3 blow out.</p> 	<p>Panel Spacer UTG-BGYA-W</p> <p>For Cassette type</p>  <p>50mm Panel spacer</p>
<p>Cassette Grille UTG-UFYC-W UTG-UFGC-W</p>  <p>For Compact Cassette type</p>	<p>Cassette Grille UTG-UGYA-W UTG-UGGA-W</p>  <p>For Cassette type</p>	<p>Insulation Kit for High Humidity UTZ-KXGA For Cassette type UTZ-KXGB For Slim Cassette type UTZ-KXGC For Compact Cassette type</p>  <p>Insulation Kit</p>
<p>Fresh Air Intake Kit UTZ-VXAA</p>  <p>For Compact Cassette type</p>	<p>Fresh Air Intake Kit UTZ-VXGA</p>  <p>For Cassette type</p>	

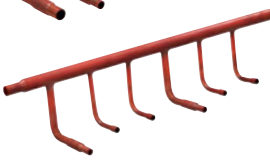
Optional Parts

Connection Units

<p>Separation Tube UTR-BP090X Gas Pipe  Liquid Pipe </p>	<p>UTP-AX090A Gas Pipe  Liquid Pipe </p>	<p>Separation Tube UTR-BP180X Gas Pipe  Liquid Pipe </p>	<p>UTP-AX180A Gas Pipe  Liquid Pipe </p>
<p>Separation Tube UTR-BP567X Gas Pipe  Liquid Pipe </p>	<p>UTP-AX567A Gas Pipe  Liquid Pipe </p>	<p>Outdoor Unit Branch kit UTR-CP567X Gas Pipe  Liquid Pipe </p> <p>UTP-CX567A Gas Pipe  Liquid Pipe </p>	
<p>Header UTR-H0906L UTR-H1806L Gas Pipe  Liquid Pipe </p>		<p>Header UTR-H0908L UTR-H1808L Gas Pipe  Liquid Pipe </p>	
<p>EV Kit UTR-EV09XB UTR-EV14XB </p>			

Specifications

Outdoor unit Branch kit

Model name	UTR-CP567X or UTP-CX567A	
Number of Outdoor unit	2 outdoor units	1
	3 outdoor units	2

Separation Tube

Model name	UTR-BP090X or UTP-AX090A	UTR-BP180X or UTP-AX180A	UTR-BP567X or UTP-AX567A
Total cooling capacity of indoor unit (kW)	28.0 or less	28.1 to 56.0	56.1 or more

Header

Model name	3-6 Branches	UTR-H0906L	UTR-H1806L
	3-8 Branches	UTR-H0908L	UTR-H1808L
Total cooling capacity of indoor unit (kW)	28.0 or less		28.1 to 56.0

EV Kit

Model name	UTR-EV09XB	UTR-EV14XB
Application Model	AS*E07GACH AS*E09GACH	AS*E12GACH AS*E14GACH

AS*: ASY(FUJITSU), ASH(GENERAL)

Applications

There are many applications for Airstage VRF systems including such markets as education, healthcare, hospitality, utilities, office buildings, apartment buildings, condominiums, and restaurants. Note: VRF Heat Recovery system provides simultaneous Heating and Cooling. System operates both Heating mode and Cooling mode.

Medical and Healthcare Facilities



VRF gives each patient individual control of their room temperature. Central control ensures that air conditioning is only delivered to rooms that are occupied.

INDIVIDUAL CONTROL

VRF gives each patient or each room individual control of their room temperature.

CLEAN AIR

VRF systems can use ductless indoor units reducing the time and expense of maintaining a HVAC system and eliminating the risk of duct-borne molds and bacteria.



CENTRAL CONTROL

Powerful central control ensures that heating and cooling are delivered to rooms that are occupied. This provides enormous savings for facilities with revolving occupancy.

MAINTENANCE

Since each refrigerant circuit has the ability to operate independently, a properly designed VRF system can add a layer of security to a HVAC system. If an individual unit needs to be shut down for repairs, the rest of the system can operate normally.



FRESH AIR

VRF systems can be integrated with fresh air systems to ensure that air quality meets the needs of the occupants. VRF provides the most comfortable environment for all occupants.

Applications

Educational and Religious Facilities

In a school, an investment in VRF is an investment in your community. VRF is more efficient than conventional systems, providing financial savings to the school for many years. Also, a quiet VRF system creates a much better learning environment for students.

HEALTHIER FACILITY

VRF systems can be integrated with fresh air systems to ensure that air quality meets the needs of the teachers and students.

CENTRAL CONTROL

Powerful central control can monitor and control individual schools, or an entire college campus, from a single location.

ZONING

Save energy by heating and cooling the classrooms that are occupied. Set temperature can pre-programmed to meet the energy budget for the school district.

COMFORT

VRF helps achieve a healthier, quieter, more comfortable and productive learning environment.

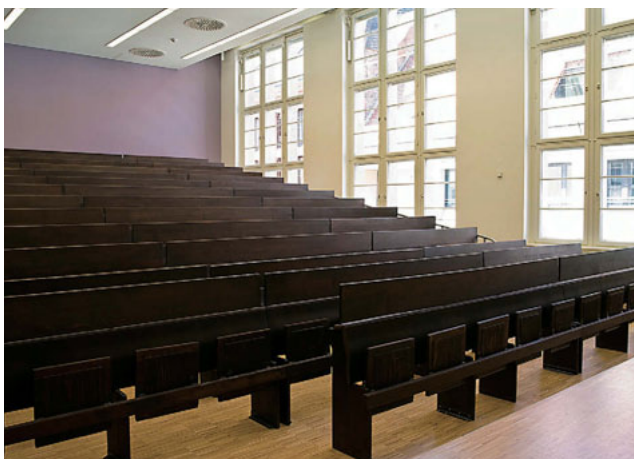

Office Buildings and Retail Spaces

VRF provides a comfortable work environment for all employees. Zoning ensures that energy is only used to cool/heat occupied offices. Quiet indoor units and precise temperature control creates the most comfortable and productive work environment.

QUIET

Indoor units and outdoor units creates a pleasant work environment and reduces noise complaints.

ZONING

Save energy by heating and cooling occupied offices. No more hot/cold calls since each zone or tenant has individual control of the set temperature.

CONTROL

Powerful controls options can manage and monitor entire building from a single location.

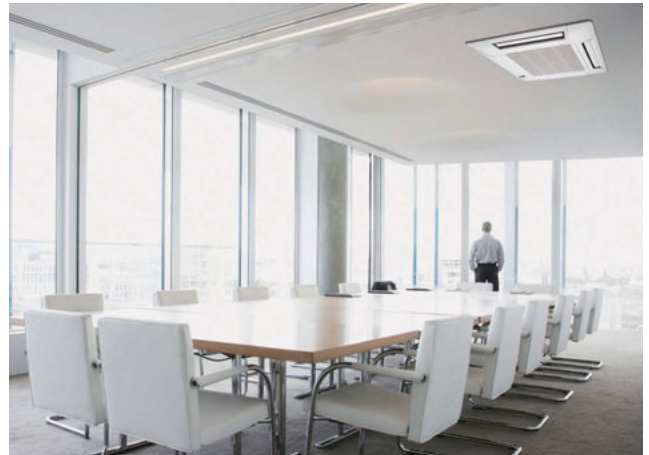

EASE OF INSTALLATION

Can be installed in occupied office spaces with minimal disruption to occupants. Can even be installed without disrupting the existing HVAC system.

FLEXIBLE

As tenants and office configurations change, VRF system configurations can also be modified (within original design constraints) to meet the needs of new tenants.

COMFORT

VRF provides a comfortable work environment for all employees. Quiet indoor units and precise temperature control creates the most comfortable and productive work environment.

FUJITSU GENERAL LIMITED

1116, Suenaga, Takatsu-ku, Kawasaki 213-8502, Japan
<http://www.fujitsu-general.com/>

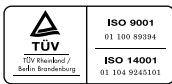

ISO 9001 Certified number : 01 100 89394
 ISO 14001 Certified number : 01 104 9245101
 Fujitsu General (Thailand) Co., Ltd.



ISO 9001 Certified number : 01 100 79269



ISO 14001 Certified number : 310102-UK
 Fujitsu General (Shanghai) Co., Ltd.



ISO 9001 Certified number : 00608Q11061R2M
 ISO 14001 Certified number : 00609E20454R2M
 Fujitsu General Central Air-conditioner (Wuxi) Co., Ltd.

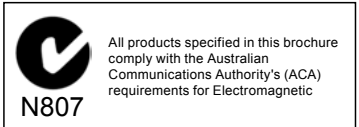

All products specified in this brochure comply with the Australian Communications Authority's (ACA) requirements for Electromagnetic

"**AIRSTAGE™**" is a worldwide trademark of FUJITSU GENERAL LIMITED and is a registered trademark in Japan and other countries or areas.

*Microsoft® and Windows® are registered trademarks of Microsoft Corporation in the United States.

*Adobe® Reader® are registered trademarks of Adobe Systems Incorporated in the United States.

*Intel®, Pentium® and Celeron® are registered trademark of Intel Corporation or its subsidiaries in the United States.

*AMD Athlon™ and AMD Duron™ are registered trademark of Advanced Micro Devices, Inc.

*Echelon®, LONWORKS®, and the Echelon logo are trademarks of Echelon Corporation registered in the United States and other countries.

*BACnet® is a registered trademark of the American Society of Heating Refrigeration and Air Conditioning Engineers (ASHRAE).

The colors may be different from the actual colors because this catalog is printed matter.

Product specifications are subject to change without notice.

Distributed by :